

TECHNICAL INSTRUCTIONS

Iron Body Series 596 SI

UTILITY IRON BODY SERIES

DESCRIPTION

The rugged Powers Type SI (single seat iron body) valve is primarily used for steam and water modulating applications with moderate pressure drops. The equal percent plug provides excellent control characteristics and is more tolerant of oversizing than linear or quick-opening plugs. The SI's control and close off characteristics are particularly well-suited to commercial water heaters, boilers, and industrial utility applications. The SI valve is available with the Powers 46 in.² and 100 in.² actuators. Actuator selection depends on valve size and flowing system pressure drop across the valve.



Normally-closed 596SI with 46 in.² actuator shown

SPECIFICATIONS

VALVE	
Body Sizes:	2 1/2" – 6"
Body Material:	Cast Iron (per ASTM A126-93 Class B)
End Connections:	125 # Flanged (per ANSI B16.1-1993)
Trim:	Bronze Composition Disc or Stainless Steel Teflon disc
Packing:	Spring loaded TFE packing
Seat Leakage:	ANSI Class IV < 0.01% leakage
Cv Range:	56-350
Rangeability:	75:1
Characteristics:	Equal Percent
Maximum Pressure:	200 psi @ Temp. <150°F
Max. Differential Press.:	50 psi for Bronze, 100 psi for Stainless Steel
Temperature Range:	40° – 281° F
ACTUATOR	
Housing Construction:	Die cast aluminum
Diaphragm Construction:	Replaceable molded neoprene
Diaphragm Area:	46 in. ² , 100 in. ²
Maximum Pressure and Temp.:	35 psi and 200°F
Ambient Shipping Limits:	- 40 to 220° F
Ambient Operating Limits:	- 20 to 220° F
Air Connection:	46 in. ² 1/4" NPT 100 in. ² 1/8" NPT
Position Indication:	1/8" increments
Mounting:	In any upright position with actuator head above 45° of the center line of the valve body. Actuator head may be swiveled to any convenient position.

Sizes	Actuators Available
2 1/2"	46 in. ² or 100 in. ² Diaphragm
3"	46 in. ² or 100 in. ² Diaphragm
4"	46 in. ² or 100 in. ² Diaphragm
5"	100 in. ² Diaphragm
6"	100 in. ² Diaphragm

TABLE OF CONTENTS

Description.....	1
Specifications.....	1
Application Information	2
Theory of Operation.....	2
Valve Sizing and Selection	3-4
Close Off Data	5
Temperature/Pressure Ratings	5
Dimensional Data	6
Installation	7
Maintenance	7
Ordering Information.....	8

CALIFORNIA PROPOSITION 65 WARNING

WARNING: This product contains chemicals known to the State of California to cause cancer and birth defects or other reproductive harm. (California law requires this warning to be given to customers in the State of California.)
For more information: www.wattsind.com/prop65

APPLICATION INFORMATION

Flowrite II Single Seated SI Valves are generally recommended for steam, hot water and chilled water applications. They are particularly suited for installations requiring tight shutoff and quick response.

THEORY OF OPERATION

On normally closed valve assemblies, the valve stem will start to open whenever the control air pressure applied against the actuator diaphragm area and the lower housing exceeds the holding force of the springs. A further increase in control air pressure will initiate a continued upward travel of the valve stem until the valve has fully opened.

On normally open valve assemblies, the stem will start to close whenever the control air pressure applied against the actuator diaphragm area and upper housing exceeds the holding force of the springs. A further increase in control air pressure will initiate a continued downward travel of the valve stem until the valve has fully closed.

The air pressure change to initiate full stem travel is known as the spring range or span. This spring span is factory set and will vary slightly as the pressure drop across the valve changes.

When the valve is at its "full open" position there is maximum flow potential through the valve. At this position, valves are compared based on flow that is directly related to the valve flow coefficient (see C_v equations in table 1). The 596 SI valves are designed so that equal changes in valve stem position provide equal percentage changes in existing flow through the valve. This is otherwise known as an equal percent valve which has a typical flow curve (figure 2) that can be used to determine flow based on stem position, pressure drop, and C_v . As you can see from the graph, these valves are less sensitive at the low end, which gives both high rangeability and high flows. These types of valves are used extensively to compensate for fluctuating system requirements (pressure, flow, load, etc.).

Valve actuators equipped with positioners provide feedback for enhanced control strategies and, as an example, are required for valve staging. Valves with positioners can utilize full control air pressure at any point in stem travel to initiate stem movement or to maintain stem position. However, the actuator springs still provide the necessary force to move the stem in the opposite direction. Use of a positioner will tend to provide faster response and ensure repeatability of stem position regardless of the load on the actuator. However, in a system where available pressure and flow requirements are relatively consistent, control valves can usually perform adequately without a positioner.

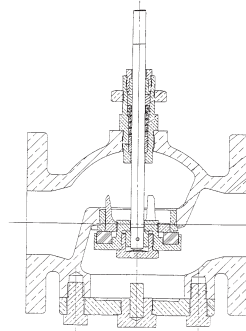

Figure 1 A- Push to Open

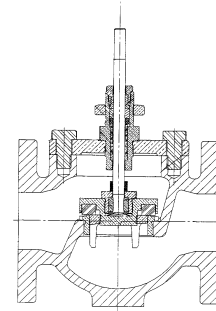

Figure 1 B- Push to Close

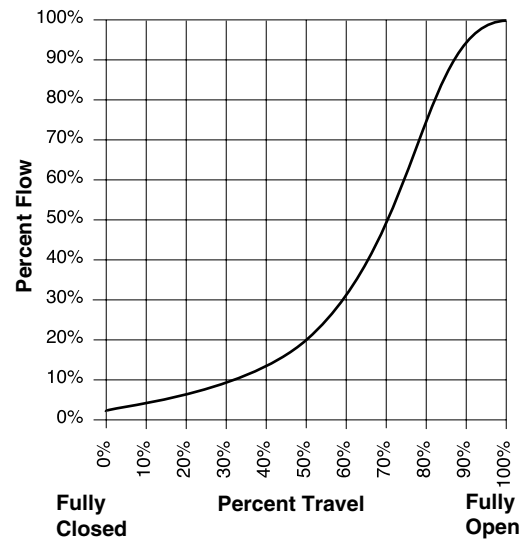

Figure 2

VALVE SIZING AND SELECTION (WATER)

The sizing of a valve is very important if it is to render good service. If it is "undersized", it will not have sufficient capacity. If it is "oversized", the controlled variable may cycle, the trim can be exposed to excessive wear or wire drawing, and you could expect reduced valve life. To help select the right valve, it is important to understand your application and its variables (controlled fluid, temperatures, pressures, min/max load, etc.). When your system variables are known and you have calculated actual demand, it is possible to select the right Powers valve for your application. The following technical data should help you in selecting a valve for your water control applications. For fluid applications other than water, contact Powers' application engineering.

$$Q = C_v \sqrt{\Delta P}$$

Where:

Q = Water flow (gpm)

Cv = Valve flow coefficient (gpm with $\Delta P = 1$ psi)

ΔP = Pressure differential, P1- P2 (psi)

P1 = Inlet pressure (psi)

P2 = Outlet pressure (psi)

On/Off Control:

These types of applications are normally line sized to reduce pressure drop and pump size. In these applications it is important to verify valve seat leakage will not result in system overheat or damage. If this is a concern, it is necessary to take precautions to alleviate this potential problem.

Proportional Control:

In applications where the close-off pressure at the valve is below 20psig, use a pressure drop of 5psi.

In applications where the close-off pressure at the valve is above 20psig, it is generally recommended to take 25-50% of the system pressure drop at the control valve to maintain good valve/system performance. Certain applications can successfully utilize lower pressure drops across the valve (5-25%) if system fluctuations are kept to a minimum. If not, the valve is considered oversized it will not effectively throttle until it is nearly closed thereby resulting in poor control.

Refer to the following table for flow....

Table - 1 Water Capacity in Gallons Per Minute

Valve Size	Cv Rating	Differential Pressure (ΔP in psi)											
		5	10	20	30	40	50	60	70	80	90	100	125
2.5	65	145	206	291	356	411	460	503	544	581	617	650	727
3	85	190	269	380	466	538	601	658	711	760	806	850	950
4	145	324	459	648	794	917	1025	1123	1213	1297	1376	1450	1621
5	235	525	743	1051	1287	1486	1662	1820	1966	2102	2229	2350	2627
6	350	783	1107	1565	1917	2214	2475	2711	2928	3130	3320	3500	3913

CAVITATION LIMITATIONS ON VALVE PRESSURE DROP

A concern in high temperature water systems is the potential for cavitation/flashing, which is caused by the downstream pressure being lower than that of the vapor pressure of the fluid. This basically causes the water to "boil" and can result in reduced flow/capacity, excessive noise, vibration, wear and should be avoided if possible. Use the following equation to estimate the maximum allowable pressure drop across the valve:

$$P_{max} = 0.5 (P1 - P_v)$$

Where:

Pmax = Maximum allowable pressure drop

P1 = Absolute inlet pressure (psia)

Pv = Absolute vapor pressure (refer to psia - Table 2)

Absolute pressure = gage pressure + 14.7

Table-2 Vapor Pressure of Water Table

Water Temp. (°F)	Vapor Pressure (psia)	Water Temp. (°F)	Vapor Pressure (psia)
40	0.12	140	2.89
50	0.18	150	3.72
60	0.26	160	4.74
70	0.36	170	5.99
80	0.51	180	7.51
90	0.70	190	9.34
100	0.95	200	11.53
110	1.28	210	14.12
120	1.69	220	17.19
130	2.22	230	20.78

VALVE SIZING AND SELECTION (STEAM)

Steam:

One can use the same reasoning for selecting a valve in steam applications as would be used for water applications. Once again, pressure drop selection is a major determining factor for good control and system performance. In general, for steam applications, the largest possible pressure drop should be taken without exceeding the critical pressure ratio.

On/Off Control:

These types of applications are normally line sized to reduce pressure drop. In these applications it is important to verify valve seat leakage will not result in system overheat or damage. If this is a concern, it is necessary to take precautions to alleviate this potential problem.

Proportional Control:

For pressures less than 15 psig, use an 80% of the gauge inlet pressure as a differential. For pressures above 15psig, use 50% of the absolute inlet pressure. In those cases where the required Cv falls between two valves, select the larger size.

One may be concerned about steam entering a heating coil at 0 psig when these large pressure drops are taken at the valve. However, flow will continue as the pressure in the coil will drop to vacuum pressures due to the steam condensation. It is essential to use proper condensate piping and steam trapping in these applications.

Table - 3 Steam Capacity in Pounds Per Hour

Steam Inlet Pressure (psig)		2			5					10				
Pressure Drop Across Valve (psi)		0.5	1	2	1	2	3	4	5	2	4	6	8	10
Valve Size	Cv Rating													
2.5	65	554	777	1082	846	1181	1426	1624	1790	1329	1839	2203	2484	2709
3	85	724	1016	1415	1106	1544	1865	2124	2341	1738	2405	2880	3249	3543
4	145	1235	1733	2413	1887	2634	3182	3623	3993	2965	4103	4914	5542	6044
5	235	2002	2809	3911	3058	4268	5157	5872	6472	4805	6650	7964	8981	9796
6	350	2981	4184	5825	4555	6357	7681	8746	9639	7156	9905	11861	13376	14589

Steam Inlet Pressure (psig)		15					25				50			
Pressure Drop Across Valve (psi)		3	6	9	12	(max) 15	5	10	15	(max) 20	10	20	30	(max) 32.5
Valve Size	Cv Rating													
2.5	65	1776	2443	2907	3255	3523	2633	3596	4242	4705	4717	6385	7454	7660
3	85	2322	3195	3802	4257	4607	3443	4702	5548	6152	6168	8350	9747	10017
4	145	3961	5450	6485	7262	7858	5873	8022	9464	10495	10522	14243	16628	17088
5	235	6419	8834	10511	11770	12736	9518	13001	15338	17010	17053	23084	26949	27694
6	350	9561	13156	15654	17529	18968	14176	19363	22844	25334	25397	34380	40137	41247

Steam Inlet Pressure (psig)		75				100				125		
Pressure Drop Across Valve (psi)		10	25	35	(max) 45	10	25	36	(max) 58	20	50	(max) 70
Valve Size	Cv Rating											
2.5	65	5618	8481	9704	10615	6394	9758	11390	13610	9832	14619	16526
3	85	7347	11090	12690	13882	8361	12760	14894	17797	12857	19117	21611
4	145	12533	18918	21647	23681	14263	21767	25408	30360	21932	32611	36866
5	235	20312	30661	35084	38379	23116	35277	41178	49205	35546	52853	59748
6	350	30251	45665	52252	57160	34428	52541	61329	73284	52940	78717	88987

Steam Inlet Pressure (psig)		150			175			200		
Pressure Drop Across Valve (psi)		25	50	(max) 83	50	70	(max) 95	50	75	(max) 108
Valve Size	Cv Rating									
2.5	65	11908	16134	19521	17518	20088	22437	18800	22254	25431
3	85	15572	21098	25527	22908	26269	29340	24585	29102	33256
4	145	26563	35990	43546	39078	44812	50051	41939	49644	56731
5	235	43051	58329	70574	63334	72627	81117	67971	80457	91944
6	350	64118	86873	105111	94327	108167	120813	101233	119830	136937

$$W = \frac{2.1 C_v \sqrt{\Delta P (P1+P2)}}{K}$$

Where:

W = Steam flow (lbs/hr)

Cv = Valve flow coefficient (US gpm with ΔP = 1 psi)

K = 1 + (0.0007 * °F superheat)

ΔP = Pressure differential, P1 - P2 (psi)

P1 = Inlet pressure (psia)

P2 = Outlet pressure (psia)

Absolute Pressure = Gage pressure + 14.7 (psia)

CLOSE OFF DATA

In all cases requiring greater close off, a preload adjustment is possible. Consult with factory for your application.

Close Off Ratings for Normally Closed Valves

Valve Size (in)	Actuator (in ²)	Close Off (Δ P in psi)		
		Signal-to-Actuator		
		3-15 PSI	1-17 PSI	(Positioner) 0-30 PSI
2.5	46	26	53	106
	100 (1U)	96	125	125
3	46	15	34	70
	100 (1U)	63	92	92
4	46	6	16	36
	100 (1U)	32	48	48
5	100 (1U)	19	29	29
6	100 (1U)	12	19	19

Close Off Ratings for Normally Open Valves

Valve Size (in)	Actuator (in ²)	Close Off (Δ P in psi)		
		Signal-to-Actuator		
		3-15 PSI	1-17 PSI	(Positioner) 0-30 PSI
2.5	46	49	86	125
	100 (1L)	125	125	125
3	46	32	58	125
	100 (1L)	90	118	125
4	46	15	30	77
	100 (1L)	48	64	125
5	100 (1L)	29	39	105
6	100 (1L)	19	26	72

TEMPERATURE/PRESSURE RATINGS

In all cases, do not exceed the temperature/pressure ratings of the valve (see figure 3). Acceptable region is shown by the shaded area.

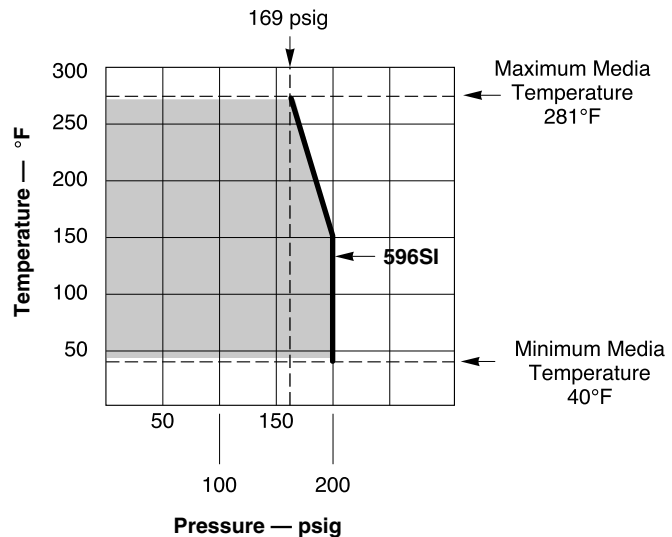

Figure 3 - Temperature and Pressure Ratings

DIMENSIONAL DATA

Table-4 Dimensions for 596 SI Series Valves

Nominal Pipe Size	2-1/2"	3"	4"	5"	6"
A	8.500	9.500	11.500	13.000	14.000
STROKE	0.938	0.938	0.938	1.938	1.938
B1	4.125	4.125	5.063	6.750	7.375
B2	3.500	3.750	4.500	5.000	5.500
C1	4.125	4.375	5.000	5.500	6.500
C2	3.875	4.250	4.875	5.500	6.375
D	10.375	10.375	10.375	N/A	N/A
E	10.000	10.000	10.000	N/A	N/A
F	16.625	16.625	16.625	19.000	19.000
G	10.313	10.313	10.313	10.313	10.313
Valve Weight (lbs)	52.00	65.00	90.00	150.00	225.00
Weight w/46"	65.00	78.00	103.00	N/A	N/A
Weight w/100"	77.00	90.00	115.00	180.00	255.00

Figure 4 - 2-1/2" to 6" Valve Bodies

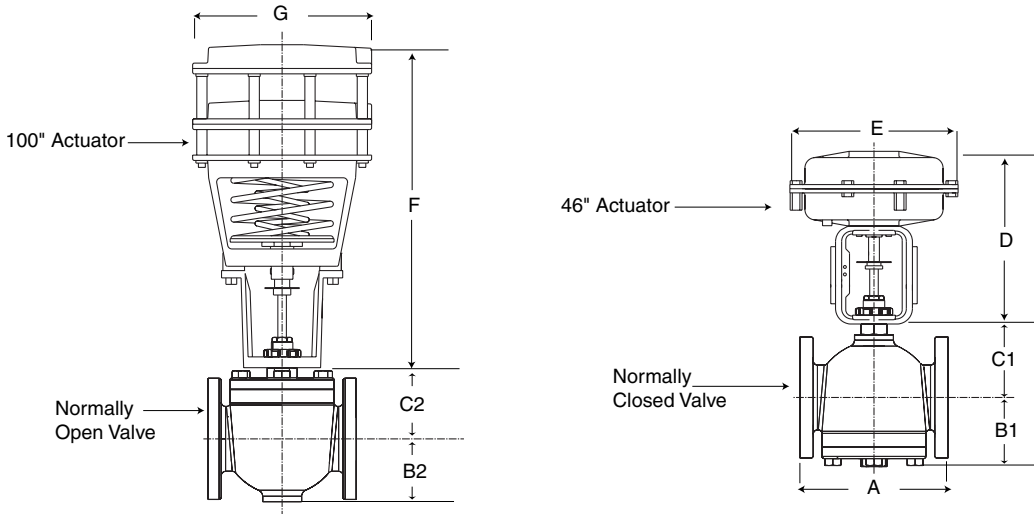
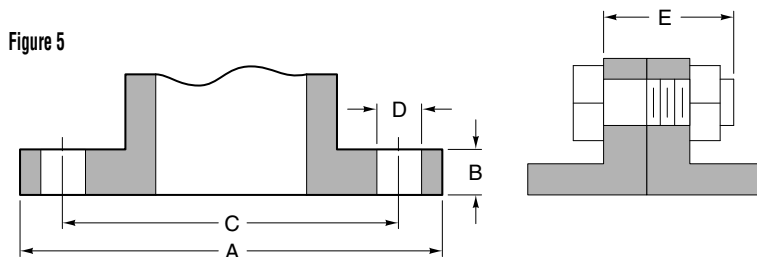

Table - 5 Flange Detail for American Standard 125 lb. Cast Iron Pipe Flanges

Valve Size	Flanges		Drilling		Bolting		Length of Machine Bolts
	Flange Diameter	Flange Thickness	Diameter of Bolt Circle	Diameter of Bolt Holes	Number of Bolts	Diameter of Bolts	
	A	B	C	D	E		
2-1/2"	7"	11/16"	5-1/2"	3/4"	4	5/8"	2-1/2"
3"	7-1/2"	3/4"	6"	3/4"	4	5/8"	2-1/2"
4"	9"	15/16"	7-1/2"	3/4"	8	5/8"	3"
5"	10"	15/16"	8-1/2"	7/8"	8	3/4"	3"
6"	11"	1"	9-1/2"	7/8"	8	3/4"	3-1/4"



INSTALLATION

Inspection

Inspect the package for damage. If damaged, notify the appropriate carrier immediately.

If undamaged, open the package and inspect the device for obvious damage. Return damaged products.

Requirements

- Pipe wrenches
- Flange gaskets, bolts/nuts
- Installer must be a qualified, experienced technician

CAUTION!

- Install the valve with the flow in the direction of the flow arrow.
- Do not exceed the ratings of the device.
- Avoid locations where excessive moisture, corrosive fumes, or vibration are present.

Mounting/Orientation

1. The valve should be mounted in a location that is within the ambient limits of the actuator. When selecting a location, allow sufficient room for valve linkage, actuator, and other accessories and for service of the product.
2. The preferred mounting position for the valve is with the valve stem vertical above the valve body. Avoid mounting the valve so that the valve stem is below horizontal.
3. On steam applications where the ambient temperature approaches the limit of the actuator, the valve stem should be mounted 45° from vertical.

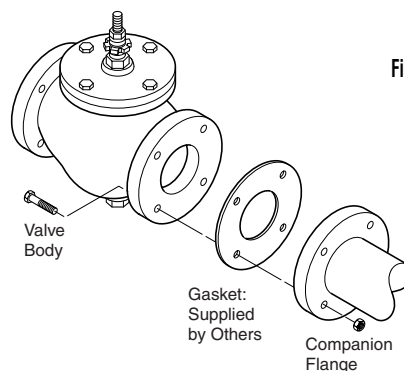

Figure 6 - Installation of Flanged End Valves

Flanged Connection

The 596SI series flanged valve bodies conform to American Standard 125 Lb. Cast Iron Pipe Flanges. The companion flanges (not provided) should be the same specification as the valve. The 125 lb. flanges have plain flat faces and should not be bolted to a raised faced flange.

1. All parts should be clean to assure the best results.
2. The pipe with the companion flanges installed should be properly supported and aligned. Be sure the companion flange is flush with the face of the valve body flange and lined up squarely.
3. Use a gasket material (not provided) that is recommended for the medium being handled.

CAUTION! Do not apply pipe dope to the valve flange, gasket, or companion flange.

4. See Figure-5 for flange and flange bolt details. Figure-6 shows the proper way a flanged valve should be mounted.

MAINTENANCE

Regular maintenance of the total system is recommended to assure sustained performance. See Table-6 for maintenance kit part numbers.

Table - 6 Maintenance Kits for 596SI Valves

Valve Description	Replacement Packing Assembly	Replacement Gaskets	Valve Repair Kit*
2.5 Normally Closed	596 Pack	596250G	SIGOBCTK
3 Normally Closed		596300G	SIHOBCTK
4 Normally Closed		596400G	SIJOBCTK
5 Normally Closed		596500G	SIKOBCTK
6 Normally Closed		596600G	SILOBCTK
2.5 Normally Open		596 Pack	596250G
3 Normally Open	596300G		SIHOBXTK
4 Normally Open	596400G		SIJOBXTK
5 Normally Open	596500G		SIKOBXTK
6 Normally Open	596600G		SILOBXTK

* Kit includes replacement packing and stem & plug assembly.

Water System Maintenance

All systems are susceptible to valve and system problems caused by improper water treatment and system storage procedures. These guidelines are provided to help avoid valve and water system problems resulting from improperly treated water or storage procedures and to obtain maximum life from the valves.

Durability of valve stems and packings is dependent on maintaining non-damaging water conditions. Inadequate water treatment or filtration can result in corrosion, scale, and abrasive particle formation. Scale and

particulates can result in stem and packing scratches and can adversely affect packing life and other parts of the hydronic system.

To maintain non-damaging conditions, follow these guidelines:

- Clean the system prior to start up.
- Use filtration equipment where needed.
- Properly store off-line systems and monitor water treatment results.
- Follow the advice of a water treatment professional.

ORDERING INFORMATION

596- **S** **I**

Size	Order Code
2 1/2".....	250
3".....	300
4".....	400
5".....	500
6".....	600

End Connections

125# Flange **F**

Valve Trim

Bronze..... **B**
 Stainless Steel..... **S**

Action

Fail Open (Air-to-Close) **X**
 Fail Closed (Air-to-Open) **C**

Packing

Teflon **T**

**ACCESSORIES
 SELECT CODE**
 (see below)

**ACTUATOR
 SELECT CODE**
 (see below)

ACTUATOR SELECT CODE

CODE	PNEUMATIC DIAPHRAGM ACTUATORS
46	46 Sq. In., 1" Max Valve Stroke with Stainless Steel Springs, adjustable start w/ 7 ~ 12 lb. Fixed span.
4X	46 Sq. In., 1" Max Valve Stroke with Extended Springs (requires positioner), adjustable start w/22 lb. span.
1U	100 Sq. In; 8-13 psi Spring Range, (Normally Closed Valves)
1L	100 Sq. In; 3-8 psi Spring Range, (Normally Open Valves)

I/P TRANSDUCERS

The "standard" 3-15 psi signal was originally designed as a transmission signal, not a valve actuation signal. The Fluid Controls Institute (in Standard 87-2) has recommended that a 1-17 psi air signal range be used when directly actuating a control valve without a positioner. Powers concurs with this recommendation, and therefore, offers a 1-17 psi I/P transducer and a 0-30 psi I/P transducer and the Accritem pneumatic controller for maximum close-off. 3-15 psi I/P transducers should be used in conjunction with positioners.

ACCESSORIES SELECT CODE

CODE	DESCRIPTION
Bellofram 1000 I/P'S	
IS	3-15 psi
TS	1-17 psi
US	3-27 psi
CONTROL/AIR TYPE 900X I/P	
ES	0-30 psi
UTILITY POSITIONER AND I/P	
BS	4-20 mA
UTILITY POSITIONER	
PS	3-15 psi
RS	3-9 psi
SS	9-15 ps
NO ACCESSORIES	
OS	No Accessories

POSITIONERS

Positioners are used for one or more of the following reasons:

- 1) To split range valves.
- 2) To eliminate unwanted valve movement caused by line pressure variations
- 3) To minimize the effects of "stick-slip"
- 4) To speed response time and/or
- 5) To increase close-off rating when I/Ps are used.

POWERS™

© 2004 Powers, a division of Watts Water Technologies, Inc.
USA Phone: 1.800.669.5430 • Fax 1.847.824.0627
Canada Phone: 1.888.208.8927 • Fax 1.888.882.1979
 www.powerscontrols.com