

VALVE DESCRIPTION

The Powers #11 Regulator is a self-actuating control valve which automatically controls the temperature of a fluid without the use of external power. Adjust the set point and the rugged self-operating #11 Regulator controls the flow of heating medium (water or steam) to maintain a constant temperature.

The instrument has a vapor pressure thermal system containing a thermally responsive fluid. This thermal system rapidly senses temperature changes at the bulb and controls the flow of heating medium through the valve to maintain the desired temperature. The thermal system features a two-ply brass bellows with six reinforcing ribs on the bellows head and thick capillary tubing walls to ensure long operating life.

The Powers #11 CD Regulator features:

- Tight shutoff when the valve is closed
- A valve stem of highly polished corrosion resistant grade 316L stainless steel to decrease friction and reduce hysteresis
- An adjusting nut mounted on ball bearings and a removable set point adjusting rod to ease set point adjustments
- A set point reference scale to aid temperature adjustments

OPERATION

A bulb is connected to a bellows containing a thermally responsive fluid. The bulb is inserted into the fluid you are trying to control (process fluid) to sense its temperature. The Regulator set point is adjusted to allow sufficient flow of heating medium (water or steam) through the valve to keep the process fluid at the desired temperature.

(A) When the temperature of the process fluid drops below the set point, the temperature of the thermally responsive liquid decreases, which decreases the vapor pressure in the bulb/bellows. The force of the resulting vapor pressure is less than the spring force, so the bellows contract and the spring extends, which raises the valve plug up from its seat. This increases the flow of the heating medium (water or steam), which raises the temperature of the process fluid.

(B) As the process fluid temperature increases toward or beyond the desired set point, the temperature of the thermally responsive fluid in the bulb increases, which causes the vapor pressure to increase. This expands the bellows, compresses the spring, and moves the valve plug down towards its seat, to reduce or stop the flow of the heating medium.

TABLE OF CONTENTS

Valve Description	1
Operation	1
Specifications	2
Applications	2
Sizing and Selection	3
Water Capacities	3
Steam Capacities.....	4
Product Identification	5
Installation.....	5
Maintenance	6
Dimensions	8
Parts	10
Accessories	12
Temp. Ranges/Bulb Sizes.....	12
Order Code	13
Preventive Maintenance	14
Troubleshooting	14
Warranty Information	14

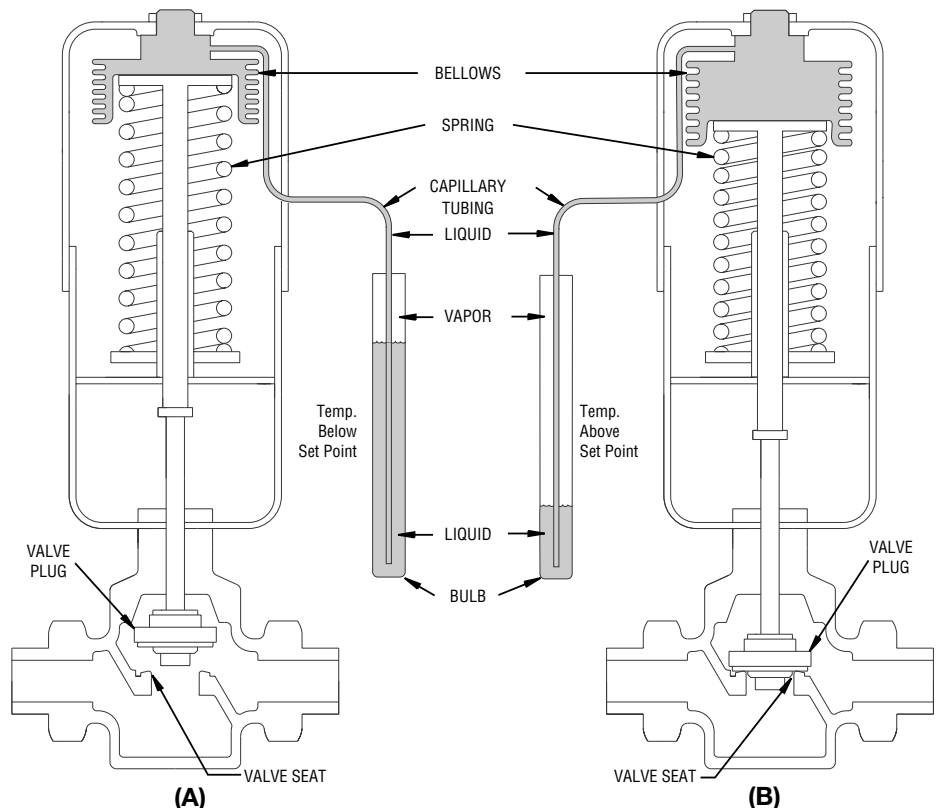

SPECIFICATIONS

Physical

Valve Sizes: 1/2" to 1-1/2" (NPT)

Body Material: Bronze

Body Rating: ANSI Class 250

Connections: Double Female Unions with pipe thread

Style: Single Seat with Composition Disc

Valve Plug Travel: See Dimensional Data on pages 8 & 9

Effective Bellows Area: 7.8 in² (50.3 cm²)

Maximum Body Temperature: 400°F (204°C)

Operating

Temperature Range: See table on page 12

Controlled Medium: Steam or Water

Max. Differential Pressure: See Tables on pages 3 & 4

Max. Allowable Overheat Temperature: 25°F (14°C) above temperature range

Max. Well Safe Pressures: See Table on page 9

Shipping Weight: See Table on page 8

Flow Characteristics: Quick Opening

Shutoff Class Rating: ANSI Class IV (leakage 0.01% of rated valve capacity)

APPLICATIONS

Powers #11 Regulators are used to automatically control the temperature of a fluid. The self-actuated regulator can easily be installed in any convenient location. Among its applications are: hot water and steam systems, fuel oil heaters, heat exchangers, air drying rooms, and many industrial processes. Below are two typical applications.

#11 CD valves are well suited to heating applications where the steam inlet pressure is under 50 psig and good shutoff is required.

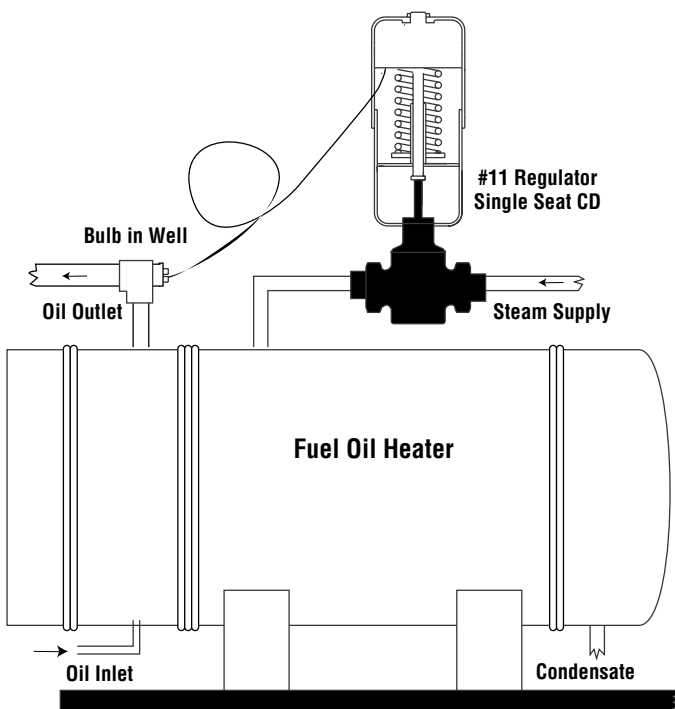

Fuel Oil Heater Application

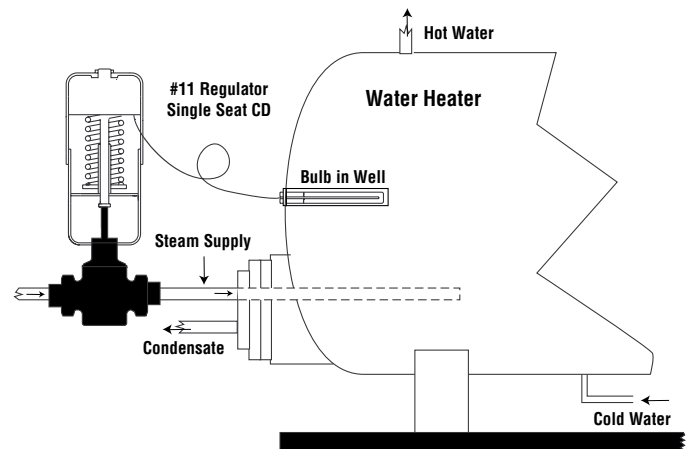

Water Heater Application

SIZING AND SELECTION

Proper sizing of the Regulator is essential for correct system operation. An undersized regulator will not allow sufficient flow at maximum load. An oversized regulator may cycle and will not utilize the full valve stroke for efficient modulation of flow. This results in poor control and shortened valve life (quicker deterioration of valve disc and seat). For these reasons, the correct sizing of the regulator for actual expected conditions is considered essential for good control.

NOTE: Select a bulb (see page 12) that has the desired set point in the upper third of the temperature range for best valve performance.

Size the #11 Regulator for actual rather than maximum conditions. **Do not** size according to pipe size; piping systems are

designed for different criteria than process controls. Refer to Powers Form #AE-1, **Valve Selection and Sizing** for further recommendations.

Maximum Operating Pressure Differential (differential for fluid flow): In order for the process medium to flow, a pressure drop must exist across the valve. "Pressure differential" is the difference in valve pressure between the inlet and outlet under flow conditions. The greater the differential, the greater the flow at any given plug position.

Though the regulator should be sized for actual conditions, you need to know the available differential at maximum flow. For optimum control, take as much differential as possible across the valve.

WATER CAPACITIES

Use a pressure drop of at least 25% of inlet pressure when sizing valves for water applications.

WATER CAPACITIES --- GPM

Valve Size	Available Sizing Pressure Differential --- PSI										Maximum Δp (PSI) Liquid
	Cv (1)	2	4	6	8	10	15	20	25	30	
1/2"	3.1	4.4	6.2	7.6	8.8	9.8	12	14	16	17	30
3/4"	5.5	7.8	11	13	16	17	21	25	28	30	30
1"	12	17	24	29	34	38	46	54	60	66	30
1-1/4"	16	23	32	39	45	51	62	72	80	88	30
1-1/2"	22	31	44	54	62	70	85	98	110	120	30

CAUTION: Do not exceed maximum pressure differentials for given valve sizes. The **maximum differential** is the pressure the valve has against it at shutoff. Too large a differential can cause valve chatter and/or prevent shutoff.

WATER CAPACITIES --- L/S

Valve Size	Available Sizing Pressure Differential --- kPa										Maximum Δp (kPa) Liquid
	7	15	30	45	60	75	100	125	150	200	
1/2"	0.2	0.3	0.4	0.5	0.6	0.6	0.7	0.8	0.9	1.1	207
3/4"	0.3	0.5	0.7	0.9	1	1.1	1.3	1.5	1.6	1.9	207
1"	0.8	1.1	1.6	1.9	2.2	2.5	2.9	3.2	3.5	4.1	207
1-1/4"	1	1.5	2.1	2.6	3	3.3	3.8	4.3	4.7	5.4	207
1-1/2"	1.4	2	2.9	3.5	4.1	4.6	5.3	5.9	6.5	7.5	207

STEAM CAPACITIES

Use a pressure drop of 50% of absolute inlet pressure (gauge pressure + 15 psi) for steam applications.

CAUTION: Do not exceed maximum pressure differentials for the given valve sizes. The maximum differential is the pressure the valve has against it at shut-off. Too large a differential can cause valve chatter and/or prevent shutoff.

STEAM CAPACITIES --- LBS./HR

		Inlet Pressure -- PSIG														
		5					10					15				
Valve Size		1	2	3	5	2	4	6	8	10	2	5	10	15	2	
		Available Sizing Pressure Differential --- PSI														
1/2"	37	52	40	56	68	85	63	88	105	118	129	70	107	145	168	81
3/4"	66	92	72	100	121	151	112	156	186	210	229	124	190	257	298	144
1"	143	200	156	218	263	330	245	340	407	459	500	270	416	560	650	314
1 1/4"	191	266	208	291	351	441	327	453	542	611	667	360	554	747	867	418
1 1/2"	263	366	286	400	483	606	450	623	746	841	917	495	762	1027	1192	575

STEAM CAPACITIES --- KG/HR.

		Inlet Pressure -- kPa														
		30					70					100				
Valve Size		5	10	15	30	5	10	15	35	70	10	25	50	100	10	
		Available Sizing Pressure Differential --- kPa														
1/2"	14	24	15	22	26	36	18	25	30	44	59	27	42	57	75	32
3/4"	26	43	27	38	46	63	31	44	53	79	105	48	74	101	132	56
1"	56	95	60	83	101	139	68	96	116	172	229	104	161	220	288	122
1 1/4"	75	126	79	111	135	185	91	127	155	229	305	138	215	293	385	163
1 1/2"	103	174	109	153	185	254	125	175	213	315	420	190	295	404	529	224

PRODUCT IDENTIFICATION

A red label should be on the front face of the thermal system. *Figure 1.* This label contains information required to properly maintain, service and order parts for this product. If there is no

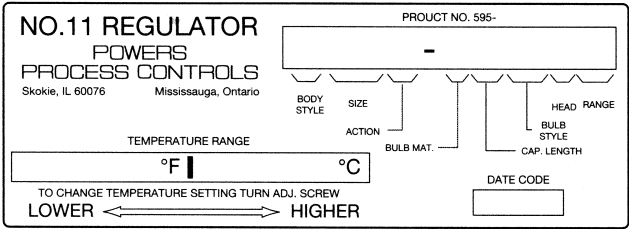

1. PRODUCT LABEL

label, look for a white label on the inside of the thermal system legs (*Figure 2A*) or the valve body vertical yoke (*Figure 2B*). When replacing the original thermal assembly or valve body, secure the old red label onto the valve or thermal system or ink the number onto the body.

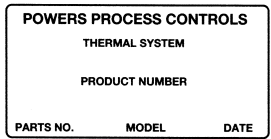

2A. THERMAL SYSTEM LABEL

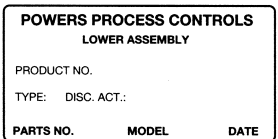

2B. VALVE BODY LABEL

INSTALLATION

TOOLS NEEDED

- Straight slot screwdriver
- 5/16" open end wrench
- 3/8" open end wrench
- 7/16" open end wrench
- 1-3/8" open end wrench
- Pliers

POSITION VALVE

1. To insure proper system operation, thoroughly flush all piping and valves to rid them of all scale, dirt and debris.
2. Select valve location with sufficient clearance to allow maintenance. Install valve in line. The direction of the arrows on the valve body must match the direction of the water or steam flow.

For best results, we recommend installing the valve in a horizontal line, and in the upright position with bellows head above valve. The valve may also be installed in any position within 90° of upright.

INSTALL BULB

3. *Figure 3a* shows proper bulb orientation. *Figure 3b* shows the special bulb needed for upwards vertical positioning.
4. *Figure 4.* For any position, fully immerse the bulb in the flow of the medium.

These instructions are for D style bulbs - for installation of other styles, refer to tag attached to bulb.

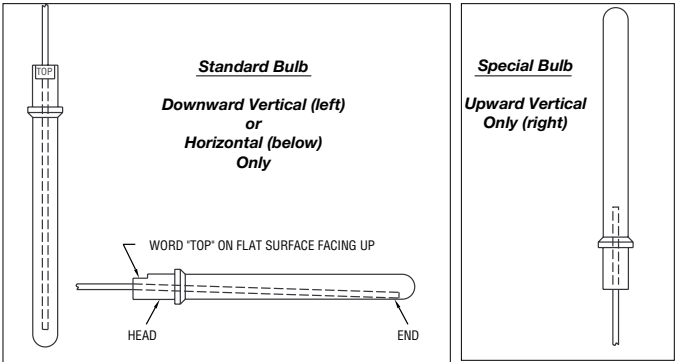

3A. BULB ORIENTATION

3B. SPECIAL BULB

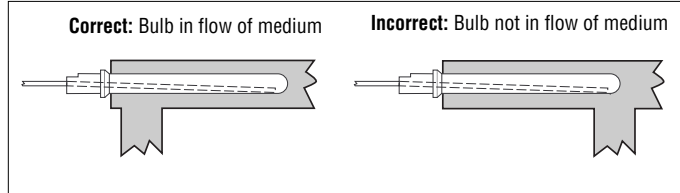

4. BULB POSITIONS

5. **Without a well:** Remove bushing from the bulb and screw it into the tank. Insert the thermostatic bulb through the bushing and tighten the union nut.

With a well: Do not use bushing. Screw well into tank, insert bulb directly into well, and tighten union nut.

ADJUST CAPILLARY TUBING

6. Coil the extra capillary, and position away from regulator operation where it is subjected to room temperature only.

WARNING: DO NOT kink, cut, sever or file the tubing. DO NOT disconnect tubing from bulb or bellows assembly. This can render the thermal system inoperable and result in severe process overheating.

ADJUST SET POINT

All regulators are factory set to control near mid-range operating temperature.

7. When adjusting the set point, make certain the heating medium is flowing through the valve and is at the operating pressure of the system.



5. ADJUSTING SET POINT

8. *Figure 5.* Make all set point temperature changes by inserting the temperature adjustment rod into one of the holes of the adjusting nut assembly. (Use the temperature adjustment setting scale only for reference)

To Raise the set point: Turn rod left to right (counter-clockwise from top).

To Lower the set point: Turn rod right to left (clockwise from top).

MAINTENANCE

Number in brackets [#] refer to part numbers on pp. 10 & 11.

To replace the composition disc only

1. Before disassembly, the **bulb must be cooled** 30°F (16°C) below the lowest point on the thermal system range, and **flow through the valve must be stopped.**
2. *Figure 5.* Relieve all pressure on the spring by turning adjusting nut assembly [31] fully right to left (clockwise from top).
3. *Figure 6.* Loosen lock nut [11] with 1-3/8" open end wrench.

Use the 1-3/8" wrench to unscrew bonnet [20] from valve body [26]. **DO NOT ALLOW** the regulator top to rotate. Lift up regulator top.

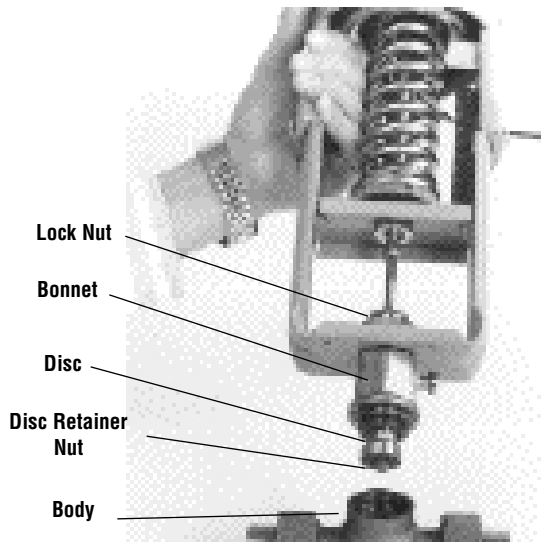

6. LIFT OFF REGULATOR FROM VALVE

4. Remove disc retainer nut [25] and replace disc [24].
5. Assemble in reverse order.

To fully disassemble regulator from valve

1. Before disassembly, the **bulb must be cooled** 30°F (16°C) below the lowest point on the thermal system range, and **flow through the valve must be stopped.**
2. *Figure 5.* Relieve all pressure on the spring by turning adjusting nut assembly [31] fully right to left (clockwise from top).

3. *Figure 7.* Remove housing bolts [6] and nuts [7] and temperature adjustment setting scale [8] and lift off thermal system [1] (housing, bellows, capillary, and bulb).



7. REMOVE HOUSING AND THERMAL SYSTEM

4. *Figure 8.* Using one 3/8" wrench and one 5/16" wrench, carefully loosen and remove piston plate assembly [2,3] from the stem extension [4]. Lift off spring [19].

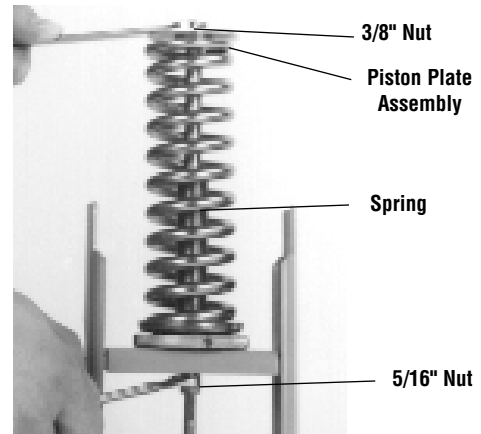

8. REMOVE PISTON PLATE/SPRING

5. *Figure 9.* Use 1-3/8" wrench to unscrew lock nut [11] and lift off the yoke and bridge assembly [9].

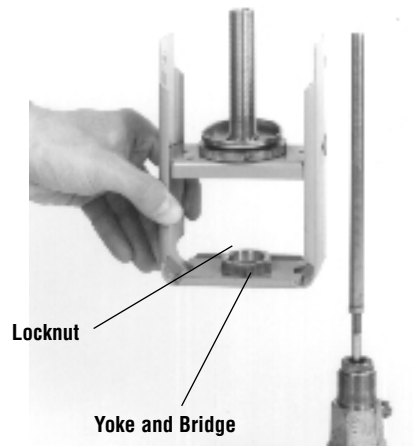

9. LIFT OFF YOKE AND BRIDGE

To replace packing

Follow **To fully disassemble regulator from valve** steps 1-5.

6. *Figure 10.* Use a 5/16" wrench on the flats of the stem extension [4] and a 7/16" wrench on the hex nut [12] to loosen and remove them.

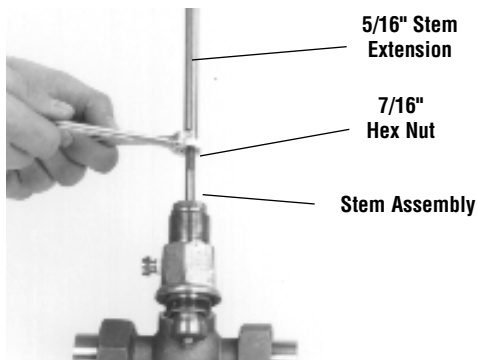

10. REMOVE STEM EXTENSION AND HEX NUT

7. Use the 1-3/8" wrench to loosen and remove bonnet [20].
8. Carefully pull out stem assembly [30]. Check the stem. It must have a polished surface that is free of roughness and pitting. Replace any parts if necessary.
9. *Figure 11.* Remove packing gland [14], and all packing components [15a-15e].

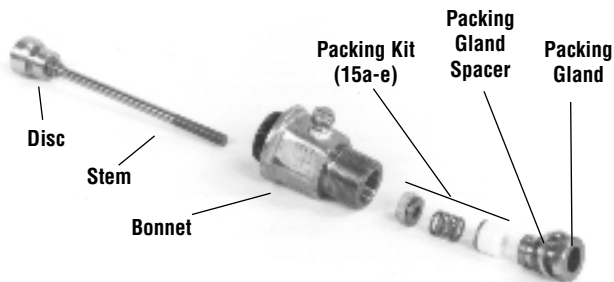

11. PACKING COMPONENTS, BONNET AND STEM

10. Clean packing chamber, taking care not to scratch seating surfaces. Be sure chamber is free of dirt and grease.
11. **For 1-1/2" Valves:** Place O-ring [21] on body before bonnet.
12. Replace bonnet [20] and stem [30] into valve body.
NOTE: You must replace the bonnet and stem before attempting to insert the packing. The rings will slide over the stem. Otherwise, you may tear the packing rings.
13. For standard packing kits, installed the parts as shown in *Figure 11.*
Slide part(s) [15e], followed by [15d] and [15c] over the stem. Gently push them into the packing chamber.
NOTE: Some kits do not include all the listed packing parts (see page 12), but the order for part installation is the same.
14. **For EP V-rings,** lubricate the rings first.
Slide each V-ring [15b] over the stem and carefully push it into the packing chamber.
15. Place the packing gland spacer [15a] on top of the bonnet.

16. Thread the packing gland assembly [14] into the bonnet. Tighten the gland assembly against the spacer.
17. With valve plug firmly seated, screw stem extension [4] to the dimension shown in *Figure 12* and tighten into place with hex nut [12].

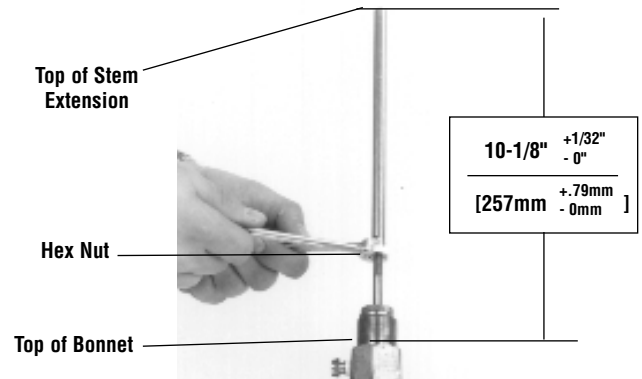

12. STEM EXTENSION REASSEMBLY DIMENSION

18. Assemble the remaining parts in reverse order.

TESTING THE THERMAL SYSTEM

If the valve is not responding to temperature change, test the thermal system.

1. Stop the flow of fluid through the line.
2. Raise the temperature of the the bulb above the set point temperature by placing it a container of hot water. This will cause the plug to fully seat.
3. *Figure 13.* With the valve plug seated, use a felt tip pen to mark where the position of the packing gland assembly on the stem.

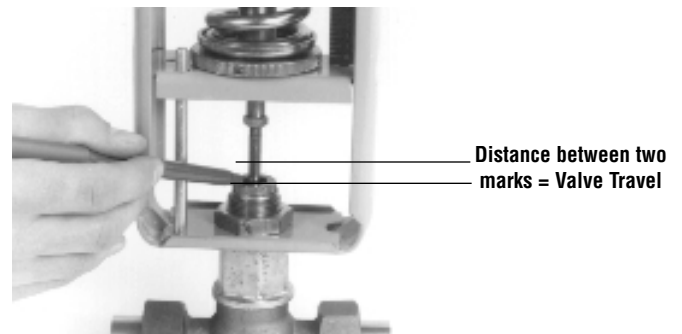

13. VALVE TRAVEL MEASUREMENT

4. Place the bulb in a pan of cool water. Cool the bulb 30°F (16°C) below set point so the valve is fully open.
5. Use the pen to mark the new position of the packing gland assembly on the stem.
6. The distance between the marks is the valve plug travel. This should correspond with the TRAVEL value in the VALVE DIMENSIONS table on page 8. **No movement or only partial movement indicates the thermal system is defective and should be replaced with a new system.**

WARNING:

Failure of the #11's thermal system will cause a heating valve to full open and a cooling valve to full close. If either of these valve states results in an unsafe process condition, a high-limit shutdown device, such as a Powers Aqua Sentry, should be used.

DIMENSIONS

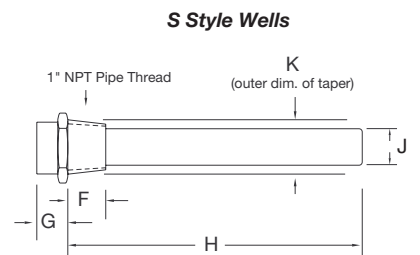
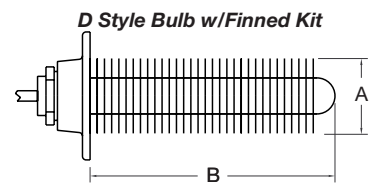
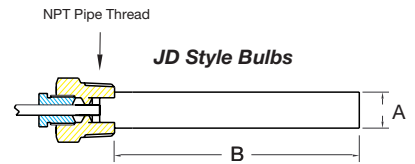
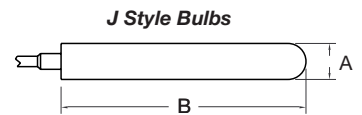
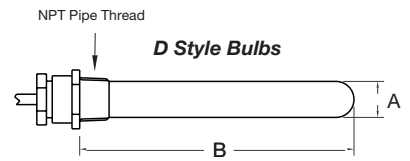
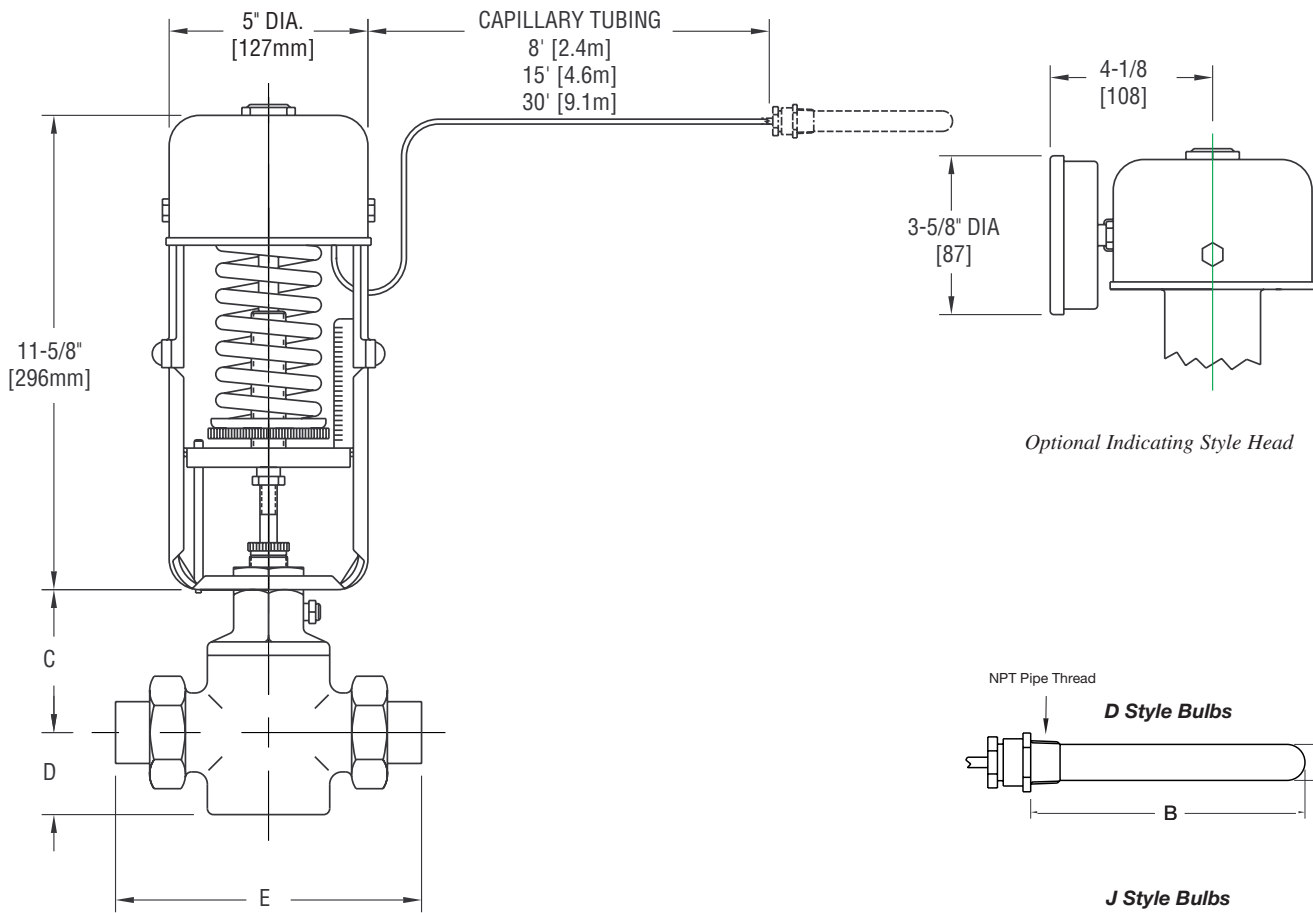

VALVE DIMENSIONS

Valve Size	C (in)	D (in)	E (in)	Travel (in)	Actual Weight (Lbs.)	
					Non Indic.	Indicating
1/2"	2 1/2	1 1/8	5 5/8	1/8	19	21
3/4"	2 5/8	1 3/8	6	3/16	20	22
1"	2 3/4	1 1/2	6 3/4	1/4	22	24
1-1/4"	3	1 3/4	7	5/16	24	26
1-1/2"	3 3/8	2 1/16	8	3/8	25	27

Valve Size	C (mm)	D (mm)	E (mm)	Travel (mm)	Actual Mass (Kg)	
					Non Indic.	Indicating
1/2"	64	29	143	3	8.6	9.5
3/4"	67	35	152	5	9.1	10
1"	70	38	171	6	10	10.9
1-1/4"	76	44	178	8	10.9	11.8
1-1/2"	86	52	203	10	11.3	12.2

BULB DIMENSIONS

Bulb Style					Max. Pressure - PSI	
Bulb Style	Size	Material	A (in)	B (in)	Shock	Non-Shock
D Fixed Union (& V-Vertical Fixed Union)	1 x 9	Copper	15/16	8	175	250
		347 Stainless	15/16	8 1/16	500	725
	1 x 20	Copper	15/16	19 7/8	175	250
		347 Stainless	15/16	19 13/16	500	725
J Plain Bulb*	1 x 9	347 Stainless	15/16	8 3/4	-	-
		Teflon Coated	15/16	8 3/4	-	-
	1 x 20	347 Stainless	15/16	20 1/2	-	-
		Teflon Coated	15/16	20 1/2	-	-
JD Adjustable	1 x 9	347 Stainless	15/16	8 3/4	500	725
	1 x 20	347 Stainless	15/16	20 1/2	500	725
G Finned Kit*	1 x 9	Copper	2	8 13/16	-	-
	1 x 20	Copper	2	20 15/16	-	-

Bulb Style					Max. Pressure - kPa	
Bulb Style	Size	Material	A (mm)	B (mm)	Shock	Non-Shock
D Fixed Union (& V-Vertical Fixed Union)	1 x 9	Copper	24	203	4445	6350
		347 Stainless	24	205	12700	18415
	1 x 20	Copper	24	505	4445	6350
		347 Stainless	24	503	12700	18415
J Plain Bulb*	1 x 9	347 Stainless	24	222	-	-
		Teflon Coated	24	222	-	-
	1 x 20	347 Stainless	24	521	-	-
		Teflon Coated	24	521	-	-
JD Adjustable	1 x 9	347 Stainless	24	222	12700	18415
	1 x 20	347 Stainless	24	521	12700	18415
G Finned Kit*	1 x 9	Copper	51	224	-	-
	1 x 20	Copper	51	532	-	-

WELL DIMENSIONS

Bulb Size								Max. Well Pressure (PSI)	
Bulb Size	Well Kit #	Well Material	F (in)	G (in)	H (in)	J (in)	K (in)	Shock	Non-Shock
1 x 9	709-193	Chrome Plated Copper	15/16	13/16	9 1/16	1	1.11	175	250
	808-478	316L Stainless Steel	1 1/16	13/16	8 11/16	1 1/64	1.11	450	675
	808-476	Carbon Steel	1	1 13/16	7 11/16	1 1/8	1.125	1000	1500
1 x 20	709-075	Chrome Plated Copper	15/16	13/16	21	1	1.11	175	250
	808-475	316L Stainless Steel	1 1/16	13/16	20 3/8	1 1/64	1.11	450	675

For Bulbs								Max. Well Pressure (kPa)	
For Bulbs	Well Kit #	Well Material	F (mm)	G (mm)	H (mm)	J (mm)	K (mm)	Shock	Non-Shock
1 x 9	709-193	Chrome Plated Copper	24	21	230	25	28	1207	1724
	808-478	316L Stainless Steel	27	21	221	26	28	3103	4654
	808-476	Carbon Steel	25	46	195	29	29	6895	10342
1 x 20	709-075	Chrome Plated Copper	24	21	533	25	28	1207	1724
	808-475	316L Stainless Steel	27	21	518	26	28	3103	4654

PARTS

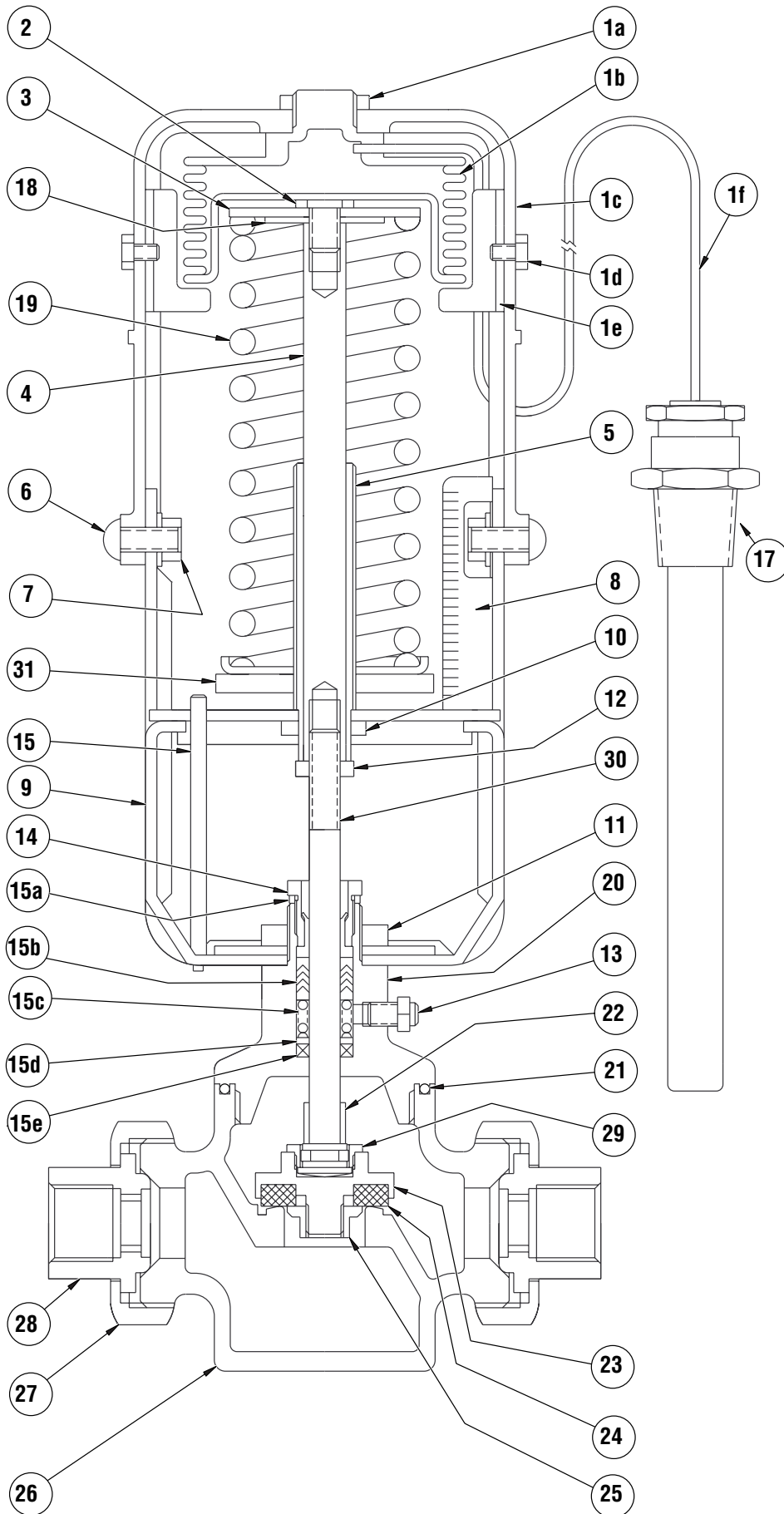

Item	Description	Valve Body Size					Qty.	Material
		1/2"	3/4"	1"	1-1/4"	1-1/2"		
1	Thermal System	Refer to Order Code					1	-
1a	Locknut	Not sold as separate part - refer to Thermal System					1	-
1b	Thermal Motor/Bellows						2	-
1c	Housing						1	-
1d	Screw						2	-
1e	Bellows Stop						2	-
1f	Bulb/Capillary Assembly						1	-
2	Piston Plate Retaining Screw	590 816					1	Stainless Steel
3	Piston Plate Washer	590 815					1	Zn plated Steel
4	Stem Extension	590808B					1	Brass
5**	Adjustment Screw	590 807					1	Brass
6	Screw	030546J					2	Zn plated Steel
7	Hex Nut 5/16 x 18	041225K					2	Cd plated Steel
8	Temp. Adj. Setting Scale	590 813					1	Al
**	Lower Housing Assembly	590 859					1	-
9**	Yoke & Bridge Assembly	Not sold as separate part					1	-
10**	Hex Nut 9/16-18 X 5/16 X 7/8	041167J					1	Zn plated Steel
11	Hex Nut 1/4-28 x 3/16 x 7/16	041 125					1	Brass
12	Locknut 1-3/8	628 008					1	Brass
13	1/8 Pipe Plug (7/16 Hex)	403 007					1	Brass
13	Stem Lubricator Kit (Optional)	590184A					1	-
14	Packing Gland Assembly	590 763					1	Brass
15	Packing Kits	See Packing Charts on page 12						-
15a	Packing Spacer						1	-
15b	Packing Set						1	-
15c	Packing Spring						1	-
15d	Packing Washer						1	-
15e	Packing Ring						1	-
16	Temp. Adj. Rod	590 820						Cd plated Steel
17	1" Tank Fitting	705 005					1	Brass
18	Spring Guide Washer	590 814	590 814	595 503	595 503	595 503	1	Steel
19	Spring	590 821		-	-	-	1	Zn plated Steel
19	Spring, inner	-	-	595 501			1	Zn plated Steel
19	Spring, outer	-	-	595 502			1	Zn plated Steel
20	Bonnet Assembly	590 131	591 808	594 499	590 140	594 481	1	Brass
21	Bonnet O-ring	N/A	N/A	084-008	084-016	084 009	1	Silicone
22	Stop Sleeve	609 019C	609 019B	601 010	609 021	609 009	1	Brass
23	Disc Holder	590 756	653 002	653 003	653 004	653 005	1	Brass
24	Disc	653 160	653 161	653 162	653 163	653 164	1	Comp. Disc
25	Disc Holder Nut	041 092	654 009	654 010	654 011	654 012	1	Brass
26	Body Assembly	601 016	590 668	594 504	594 489	594 514	1	Bronze
27	Union Nut	601 004	602 004	609 004	610 004	611 004	1	Bronze
28	Union Tail Piece	601 005	602 005	609 003	610 003	611 003	1	Brass
29	Stem Retainer	654 016	654 017		654 019		1	Brass
30	Stem Assembly	594 815A	594 819		594 818A		1	-
31**	Temp. Adj. Nut Assembly	590 829					1	-
	Valve Assembly	590-963	590-964	590-965	590-966	590-967		

ACCESSORIES

Packing kits can be ordered to replace parts in the packing assembly (See pages 10 & 11).

Kit #	Material	Valve Size	Stem Size	Usage	Parts	Lubricant
591 927	Teflon V-ring	1/2" - 1-1/2"	1/4"	Effective from 200°F-400°F Steam: 50 psi to max. valve rating	15A, 15B 15C, 15D 15E	None
594 220	EP V-ring	1/2" - 1-1/2"	1/4"	Effective from 0°F-300°F Steam: 50 psi to max. valve rating Water: up to maximum PSI valve rating	15A, 15B 15C, 15D 15E	Silicone required for installation (optional for service)
594 289	TFE Split Ring	1/2" - 1-1/2"	1/4"	For replacement only Effective from 40°F-366°F	15B, 15D	Silicone Part #087 126

Kit #	Bulb Dims.	Width (in)	Length (in)	Description
701 549	1 x 9	2	8 13/16	G Style Finned Kit (Copper)
701 550	1 x 20	2	20 15/16	G Style Finned Kit (Copper)

Finned Bulb Kits may be added to style "D' Bulbs

TEMPERATURE RANGES/BULB SIZES

For ordering thermal systems, refer to order code on page,
Powers #11 product Specification Brochure, or call Powers.

Bulb Size	Bulb Temp. Range	Order Code
	Single Seat 1/2" to 1-1/2" Heating DA Only	
1" x 20"	10-70°F (-12-21°C)	01
	55-115°F (13-46°C)	02
	85-145°F (29-63°C)	03
1" x 9"	110-170°F (43-77°C)	05
	130-190°F (54-88°C)	06
	140-200°F (60-93°C)	07
	170-230°F (77-110°C)	08
	200-250°F (93-121°C)	09
	230-290°F (110-143°C)	10
	270-330°F (132-166°C)	11

ORDER CODE

	Valve Assembly					Thermal System Assembly				
595-										
Valve Type Single Seat Composition Disc	CD									
Valve Sizes 1/2" 3/4" 1" 1-1/4" 1-1/2"	050 075 100 125 150									
Applications Heating	H									
Bulb/Capillary Material & Length Copper 8' Copper 15' Copper 30' Stainless Steel 8' Stainless Steel 15' Stainless Steel 30' Teflon over Copper 15' (J Bulb Only) Teflon over SS 15' (J Bulb Only)	C08 C15 C30 S08 S15 S30 T15 O15									
Bulb Size Fixed Union (N/A Teflon) No Pipe Fitting (N/A Copper) Adj. Union (N/A Teflon) Fixed Union (D Type) Vertical	D J A V									
Head Assembly Non-Indicating Indicating	N I									
Range/Bulb Size See temp. range chart on page 12 Select Range with Set Point in UPPER THIRD for best performance.	##									

For additional information on your application or equipment, please contact a Powers application engineer.

PREVENTIVE MAINTENANCE

Once every three months, inspect the Regulator as follows:

1. Visually check for leaks from the valve body joints, piping-to-valve connections, packing and stem areas
2. Visually check for excessive corrosion on the regulator, including the bellows, capillary, bulb, thermal system legs, bridge, and yoke. Also check for excessive corrosion on the valve body.
3. Perform the instructions in **Testing the Thermal System**. Less than full valve travel may indicate a leak in the bellows, capillary, or bulb, or other problems. This may result in excessive temperature in the process.
4. Test the temperature adjusting nut assembly for freedom of movement (see **Adjust Set Point** for instructions).
5. Remove bulb from the process fluid and check for excessive corrosion, or erosion that may weaken the bulb and/or cause thermal system failure.

TROUBLESHOOTING

WARNING: Failure of the thermal system will result in a constant rise in temperature (or constant high temperature) of the fluid which you are trying to control.

• Erratic temperature control (valve cycles too hot/too cold)

1. Valve sized incorrectly. Verify valve selection.
2. Regulator is controlling at incorrect set point. Refer to **Adjust Set Point**.
3. Bulb is poorly positioned and/or oriented, and will not control the actual temperature of the heating/cooling medium. Refer to **Install Bulb**.
4. Incorrect type of bulb is being used. See Table on page 11.
5. The valve stem is sticking. Lubricate the stem.
6. The valve stem is bent. Refer to **Maintenance** for disassembly instructions and replace.
7. Packing gland assembly too tight. Loosen packing gland nut [14].
8. Faulty or incorrect steam traps. Replace with correct steam trap.

CALIFORNIA PROPOSITION 65 WARNING

WARNING: This product contains chemicals known to the State of California to cause cancer and birth defects or other reproductive harm.
(Installer: California law requires that this warning be given to the consumer.)

For more information: www.wattsind.com/prop65

9. Very wet steam. Install a high pressure steam trap just ahead of the valve to drain off condensate that collects in the steam line.

• Regulator Does Not Shut Off

1. Pressure differential is greater than allowable pressure drop. Refer to **Water Capacities** and **Steam Capacities** tables.
2. Disc is worn. Replace disc (refer to **Maintenance**).
3. Foreign material between the disc and the valve plug seat. Refer to **Replace only the composition disc** for disassembly. Clean.
4. Bulb is poorly positioned and/or oriented, and will not control the actual temperature of the heating/cooling medium. Refer to **Install Bulb**.
5. Incorrect type of bulb is being used. See Table on page 11.
6. Valve sized incorrectly, causing wire drawing and leakage. Refer to **Sizing Information**.
7. Packing gland assembly is too tight, locking valve stem. Loosen packing gland assembly and lubricate if desired.
8. Bent valve stem; need to replace. Refer to **Maintenance** for disassembly.
9. Thermal system failure. Refer to **Testing the Thermal System**.
10. Temperature adjusting nut assembly raised too high. Refer to **Adjust Set Point**.

• Valve "chatters"

1. Regulator installed with the flow of the control medium in reverse of arrow direction on valve body.
2. Pressure differential too high, refer to Tables on pages 3 and 4 for correct pressure differential range.
3. Trapped condensate in line. Install a steam trap just ahead of the regulator to drain off condensate that collects in the steam line.

• Constant rise in process fluid temperature

1. A constant rise in temperature may indicate the thermal system is leaking charge and/or the valve has failed in a partially or fully open position. This would allow a constant flow of heating medium, which would overheat the fluid which you are trying to control.