

11

Self-Operating Temperature Regulators

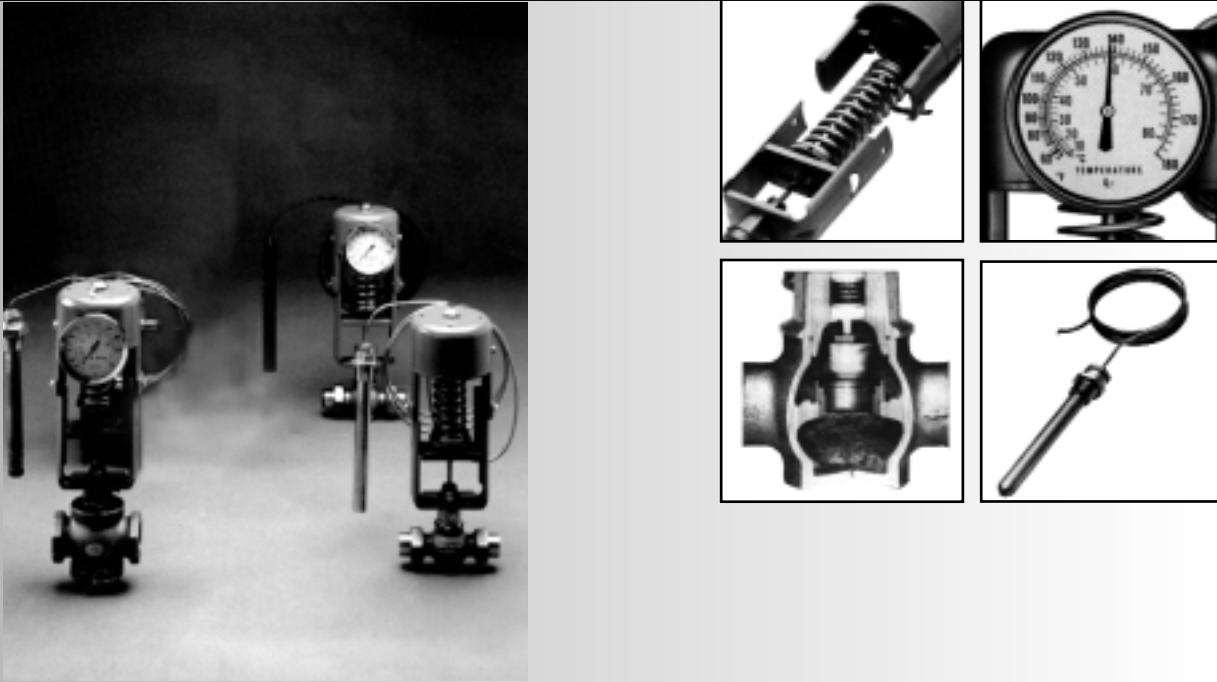

**Remote Bulb for Heating, Cooling, Mixing
and By-Pass Applications**

POWERS™

Water Tempering Innovation Since 1891

Powers #11 Regulators

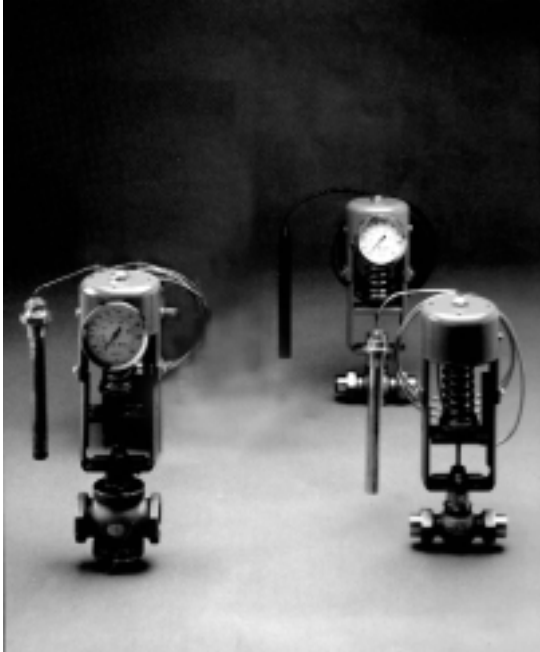

With Powers #11 Self-Operating Temperature Regulators, you no longer need external power to control your process. Just one temperature set-point adjustment to make and the rugged, self-operating #11 Regulator controls the flow of heating or cooling medium and maintains a *uniform* temperature.

So whether you're using processing equipment, heat exchangers, or machinery, Powers #11 Self-Operating Temperature Regulators are the easy solution to your control problems.

Table of Contents

	Page
#11 Features	4
Component System Thermal System Options	5
#11 Type ST Regulators for Heating or Cooling	6
#11 Type CD Regulator for Heating	8
#11 Type DS and DB Double Seat Regulators for High Capacity Heating or Cooling	10
#11 Type WM Water Mix Regulators for Water Mixing	12
Installation Information	14
Special #11 Regulators, Optional Accessories	14
Sensing Bulbs and Protective Wells	15
#11 Regulator Sizing: Valve Sizing, Maximum Operating Pressure Differential, Load Calculations	16
#11 Regulator Sizing Calculations and Charts—English	17
#11 Regulator Sizing Calculations and Charts—Metric	19
Sizing Mixing Regulators—Sizing Capacities	21
How to Order... ..	22

Powers #11 Features

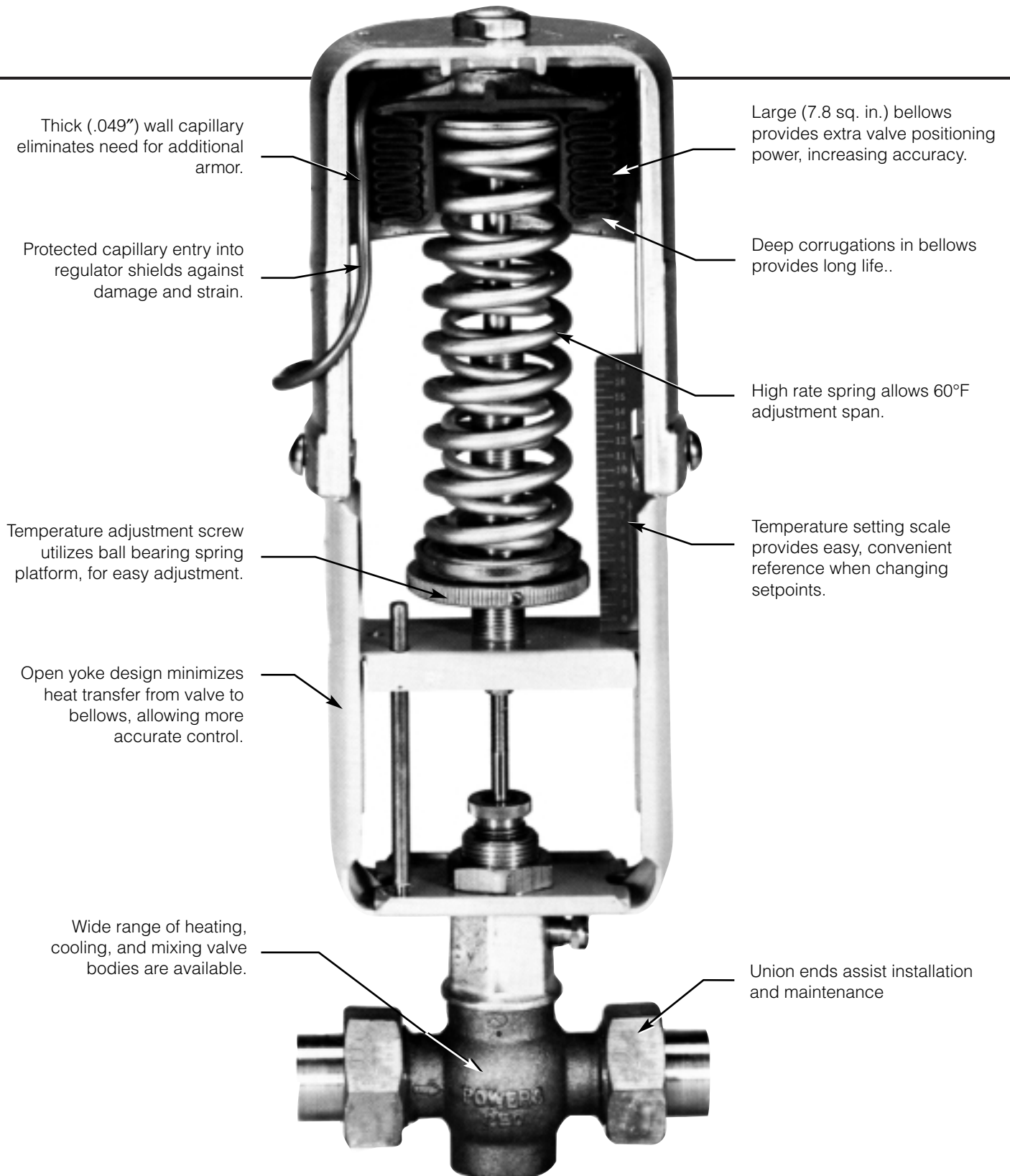

Component System

Thermal System Options

Powers No. 11 Regulator capability includes **interchangeable** sensing and control “components” for minimum downtime, greater flexibility, and extra economy. Any of 29 thermal systems (composed of remote bulb, capillary, and bellows) can be teamed up with 35 standard valve assemblies. This means approximately 1,000 standard models are available to meet virtually every process requirements.

If a thermal system is damaged—or if process changes require a different temperature range—replacement can be made in minutes without removing the valve assembly from the supply line. Similarly, a single thermal system can accommodate a variety of valve types and sizes.

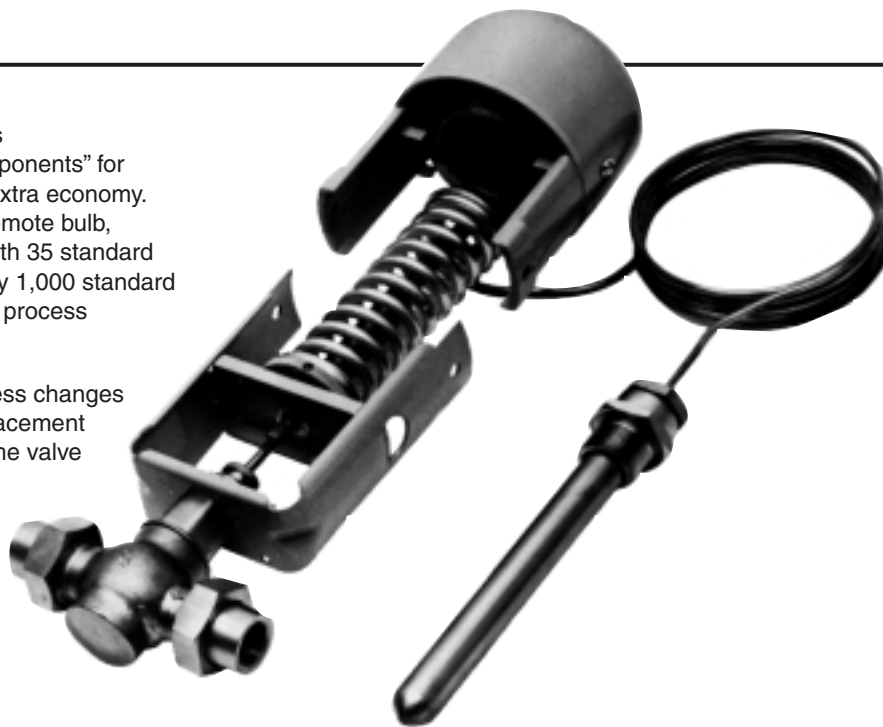

The Thermal System is the key component of a #11 Regulator. It senses the process temperature and provides power to stroke the valve. The #11 Thermal System offers tremendous flexibility through its wide range of options. Standard features and options are listed below. (See “How to Order” section, pp. 22–23, for specifying #11 Thermal System Options.)

Optional Dial Indicator

- Stainless steel case
- Rotates in any direction
- Fast response
- Dual °F / °C scale
- Wide availability of temperature ranges. (See “How to Order” section, pages 22–23, for range availability.)

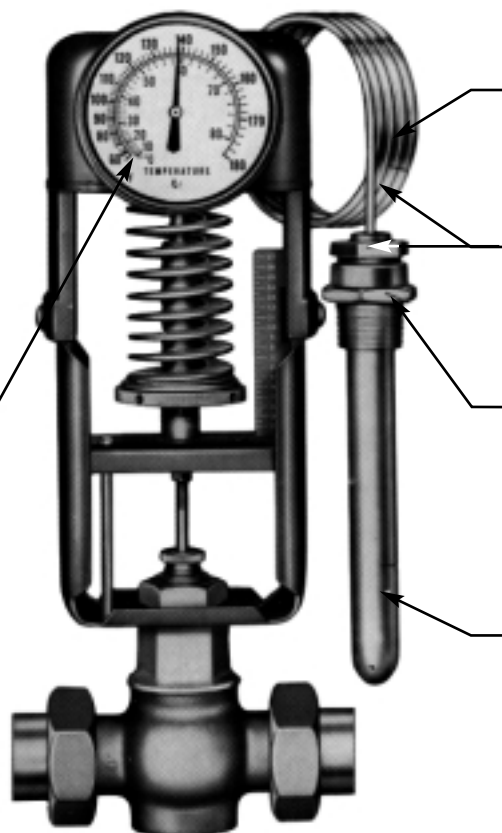

Capillary Length

- Standard 8’
- Optional 15’ or 30’

Bulb and Capillary Material

- Standard: Copper
- Optional: Stainless steel or Teflon

Bulb Fitting

- Standard Style D (Fixed Union)
- Optional Style A (Adjustable Union), Style J (Plain Bulb), or Style V (Vertical Bulb)

Bulb Size

Usually dictated by range and valve selection. See “How to Order” section (pp. 22–23) for applicable bulb size.

Powers #11 Type ST Regulator

Heating or Cooling
Size ½" to 1"
with Stainless Steel Trim

Application: #11 Type ST Regulator is well-suited for heating and cooling applications where good shutoff is required or where high inlet pressures cause a large pressure differential across the valve. The Type ST is normally the single seat valve used for cooling applications, and steam applications above 50 PSI.

(Maximum leakage @ closure is 0.1% of maximum flow)

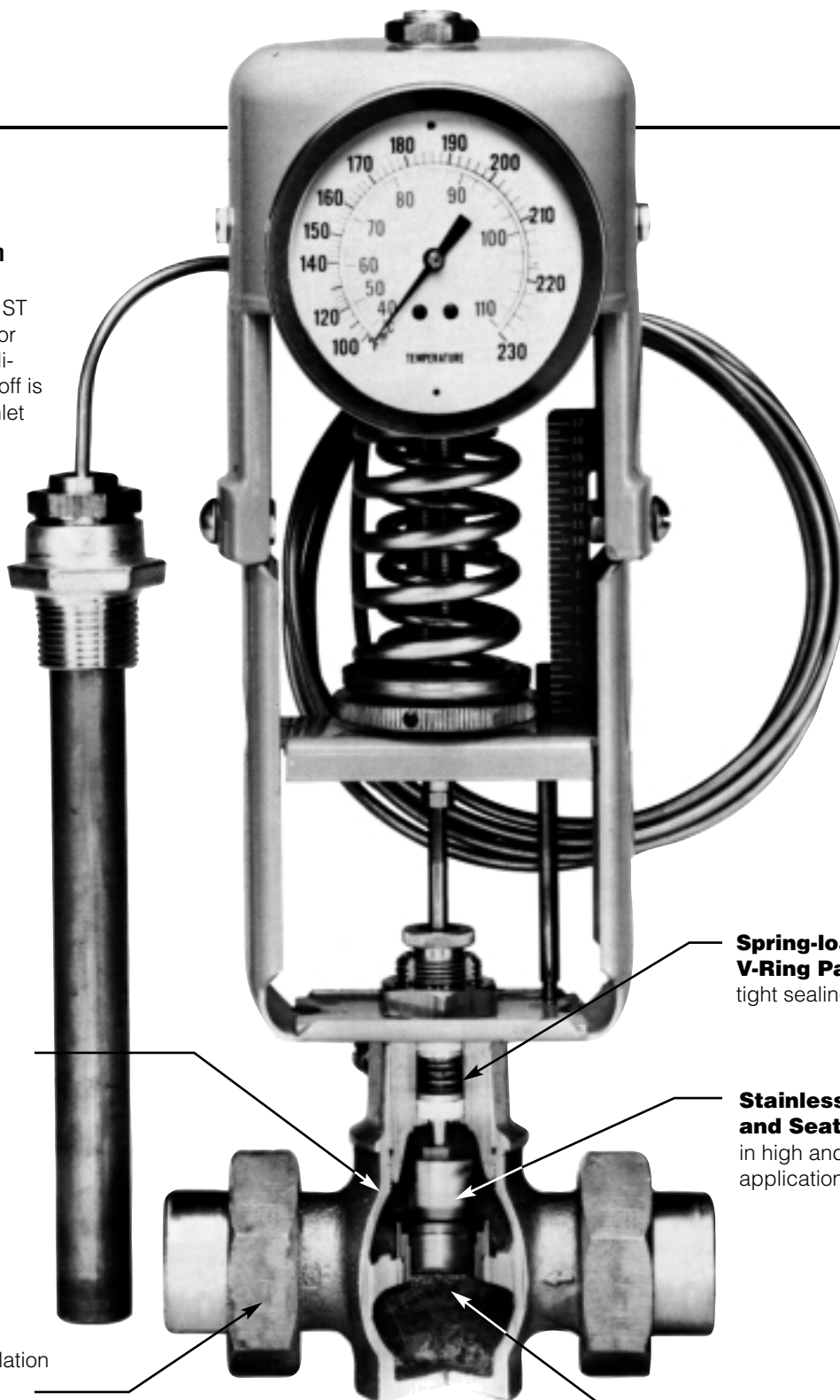

Self-Aligning Plug
assists with tight shutoff.

Union ends ease installation
and maintenance

Spring-loaded V-Ring Packing provides
tight sealing and long life.

**Stainless Steel Plug
and Seat** provide long life
in high and low pressure
applications.

Reduced Ports are
available for low flow
applications.

Selection

Refer to Load Calculations (page 16) to determine the valve capacity required for your process.

Next, refer to the Valve Sizing Charts (pages 16–21) to select valve size matching your capacity requirements.

How to Order

Refer to the product number guide (on pages 22–23) to match your valve and thermal system selections and determine product number.

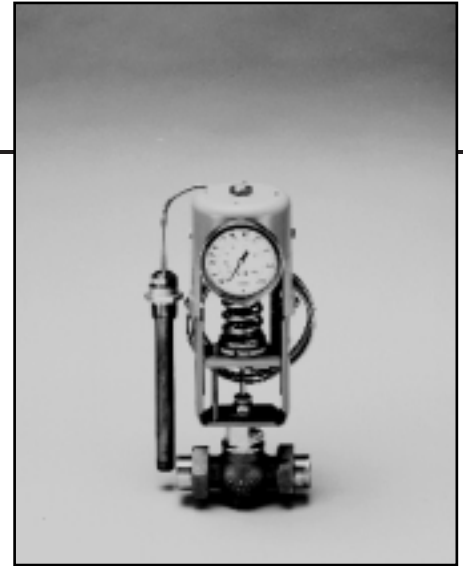

Type ST Dimensions

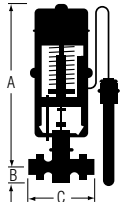
	Valve Style	Material and Connections	Valve Size	A in. (mm)	B in. (mm)		C in. (mm)	Shipping Weight lbs. (kg)
					Heating	Cooling		
	Single Seat Stainless Steel Trim	Bronze body, double female unions	1/2"	14 1/8 (359)	1 1/4 (32)	1 3/4 (44)	5 5/8 (143)	21 (9.5)
			3/4"	14 1/4 (362)	1 5/8 (35)	2 (51)	6 (152)	20 (10)
			1"	14 3/8 (365)	1 1/2 (38)	2 1/4 (57)	6 3/4 (171)	22 (11)

Specifications

Body: Bronze ANSI Class 250

Connections: Union ends

Trim: Stainless steel

Sizes	1/2A	1/2B	1/2C	1/2D	1/2	3/4	1
C_v	.25	.50	1.0	2.0	2.6	4.6	10.5
Max. Pressure Differential (psi/kPa)		200 (1379)	200 (1379)	200 (1379)	200 (1379)	140 (965)	70 (483)

Powers #11 Type CD Regulator

Heating

Size 1/2" to 1 1/2"

Bronze trim with
Composition Shut Off Disc

Application: The #11 Type CD Regulator is well-suited for heating applications where the steam inlet pressure is under 50 psi and good shut-off is required. The Type CD is only available for steam service.

(Maximum leakage @ closure is .01% of maximum flow)

Spring-loaded V-Ring Teflon Packing

provides good sealing,
long life, and requires no
lubricant.

Union ends

ease installation and
maintenance.

Composition disc

assists shut-off

Self-aligning plug

assists tight shut-off.

Large port area

provides extra capacity.

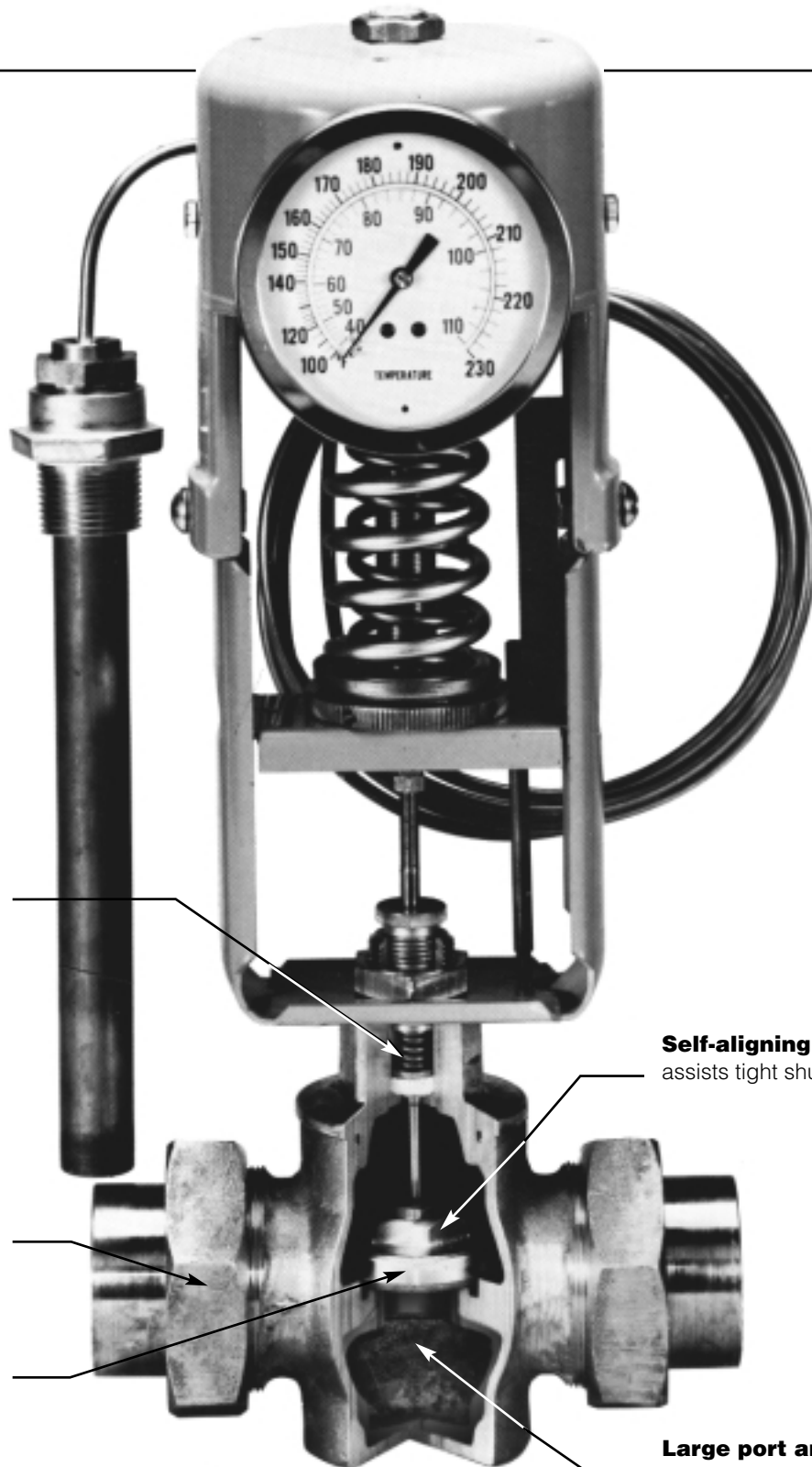

Selection

Refer to Load Calculations (page 16) to determine valve capacity required for your process.

Refer to Valve Sizing Charts (pages 16–21) to select valve size matching your capacity requirements.

How to Order

Next refer to the product number guide (pages 22–23) to match your valve and thermal system selections and determine product number.



Type CD Dimensions

	Valve Style	Material and Connections	Valve Size	A in. (mm)	B in. (mm)		C in. (mm)	Shipping Weight lbs. (kg)
					Heating	Cooling		
	Single Seat Composition Disc	Bronze body, double female unions	1/2"	1 1/8 (360)	1/8 (29)	N/A	5 5/8 (143)	19 (8.6)
			3/4"	1 1/4 (363)	1/8 (35)	N/A	6 (152)	20 (9.1)
			1"	1 4/8 (366)	1 1/2 (38)	N/A	6 3/4 (171)	22 (10)
			1 1/4"	1 4/8 (372)	1 1/4 (44)	N/A	7 (178)	24 (10.9)
			1 1/2"	15 (382)	2 1/16 (52)	N/A	8 (203)	26 (11.3)

Specifications

Body: Bronze ANSI Class 250

Connections: Union ends

Trim: Bronze

Sizes	1/2"	3/4"	1"	1 1/4"	1 1/2"
C_v	3.1	5.5	12.0	15.8	22.0
Max. Pressure Differential (PSI/kPa)— Steam	50 (345)	50 (345)	50 (345)	45 (310)	30 (207)
Max. Pressure Differential (PSI/kPa)— Water	30 (207)	30 (207)	30 (207)	30 (207)	30 (207)

Powers #11 Type DB and DS Double Seat Regulators (1" to 2")

Heating or Cooling
Sizes 1" to 2"
Double Seat
Bronze or Stainless Trim

Application: The #11 Double Seat Regulators are normally used in applications where single seat regulators do not have enough capacity. Double Seat Regulators do not have tight shut-off (when new, leakage = 0.5% of max. flow), and should not be used where leakage can cause overheating in low capacity heating systems (e.g. Heat Exchangers). Double Seat Regulators will work well in heating systems that have storage capacity (e.g., tank type water heaters, or constant flow heat exchanger systems with storage tanks) and are excellent for cooling applications which usually utilize some additional method of bypassing water around the #11 Regulator.

Bronze trim is suitable for water and steam inlet pressures below 50 psi. Stainless steel trim should be used when inlet pressure is above 50 psi.

Double Seat Style
provides extra capacity.

Union ends
ease installation and maintenance size 1"-2"
(Bronze body).

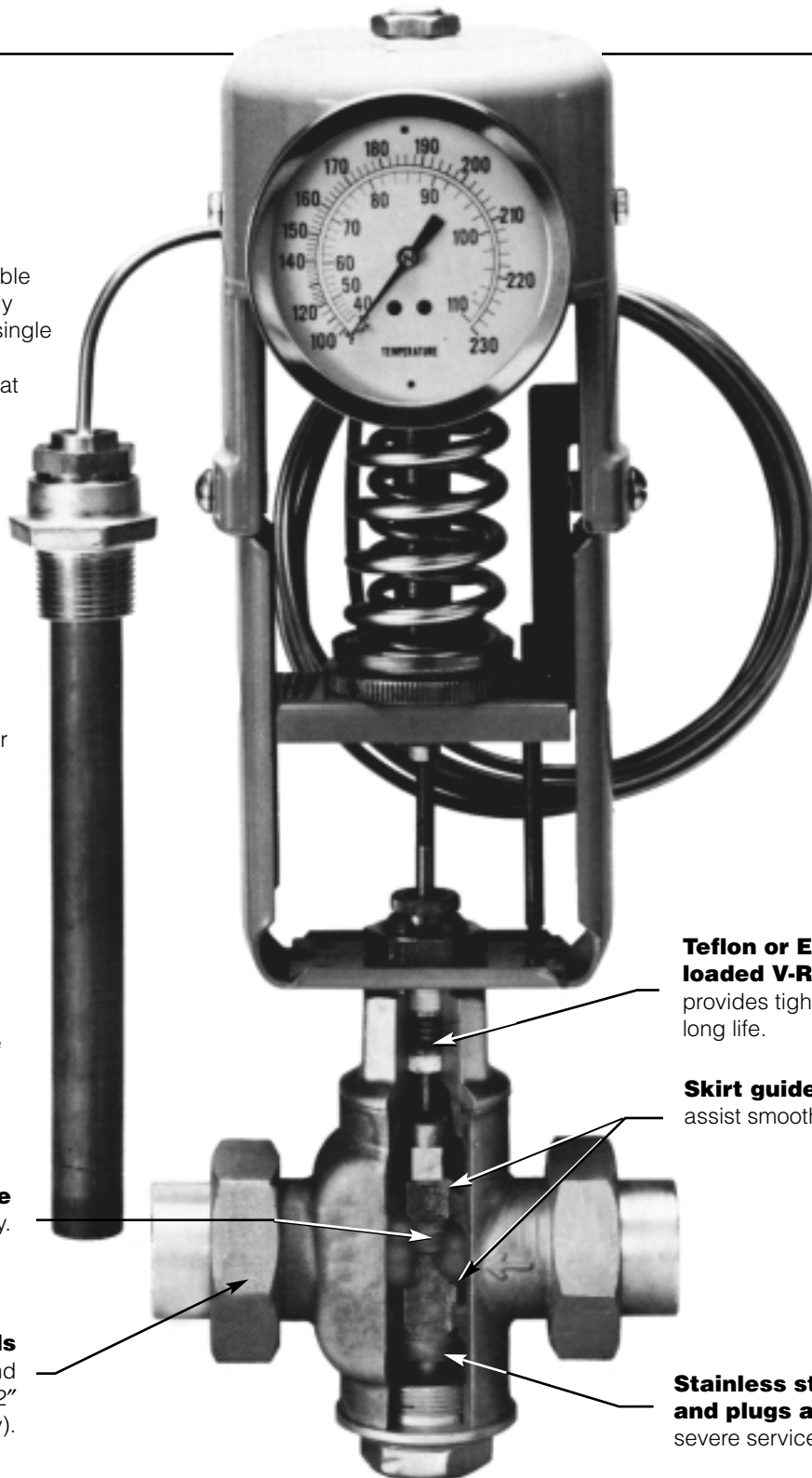

Teflon or EPT spring-loaded V-Ring packing
provides tight sealing and long life.

Skirt guided plugs
assist smooth operation.

Stainless steel seats and plugs available for severe service applications.

Selection

Refer to Load Calculations (page 16) to determine valve capacity required for your process.

Refer to Valve Sizing Charts (pages 16–21) to select valve size matching your capacity requirements.

Type Description

- DB Double Seat Bronze Trim, Size 1" to 2"
- DS Double Seat Stainless Trim, Size 1" to 2"



How to Order

Refer to the product number guide (pages 22–23) to match your valve and thermal system selections and determine product number.

Double Seat Regulator Dimensions

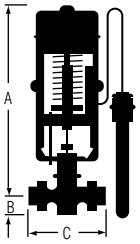
	Valve Style	Material and Connections	Valve Size	A in. (mm)	B in. (mm)		C in. (mm)	Shipping Weight lbs. (kg)
					Heating	Cooling		
Double Seat	Bronze body, double female unions, Types DB, DS	1"	15 (381)	2 1/8 (54)	2 3/4 (70)	6 3/4 (171)	24 (11)	
		1 1/4"	15 1/4 (387)	2 1/2 (64)	3 (76)	7 (178)	26 (12)	
		1 1/2"	15 3/8 (390)	2 5/8 (67)	3 1/4 (83)	8 (203)	28 (13)	
		2"	16 1/2 (419)	3 5/8 (92)	4 3/8 (111)	9 5/8 (244)	39 (18)	

Specifications

Body: 1" to 2" Bronze ANSI Class 250, 2 1/2" to 4" Iron ANSI Class 125

Connections: 1" to 2" Union Ends, 2 1/2" to 4" Flanged

Trim: Bronze or Stainless Steel

Sizes	1"	1 1/4"	1 1/2"	2"
C_v	13.5	22.0	28.0	53.0
Max. ΔP Bronze (PSI/kPa)	50 (345)	50 (345)	50 (345)	50 (345)
Max. ΔP Stainless Steel (PSI/kPa)	150 (1034)	150 (1034)	150 (1034)	125 (862)

Powers #11 Type WM Regulator (1/2" to 2")

Size 1/2" to 2"
Water Mix Three-Way
Bronze or Iron Body,
Bronze Trim

Application: The #11 Type WM/IM Regulator is typically used for domestic or process water tempering. It is also used for bypass control (in lieu of a diverting valve), but must be piped as a mixing valve (two inlets, one outlet).

(Maximum leakage @ closure is .01% of maximum flow)

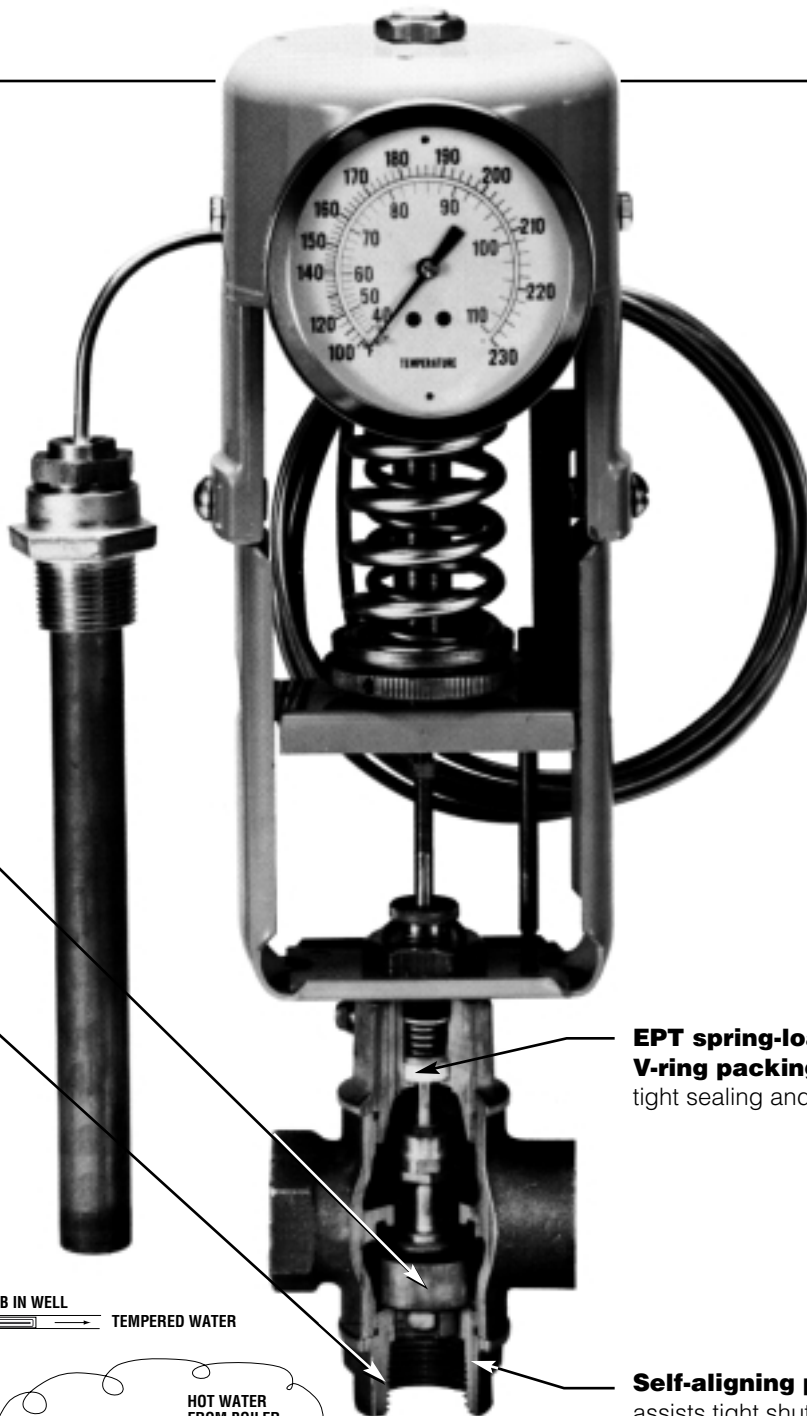

EPT Discs (1/2" to 2") assist shut-off.

Lower guide stabilizes plug, assisting shut-off and modulation.

EPT spring-loaded V-ring packing provides tight sealing and long life.

Self-aligning plug assists tight shut-off.

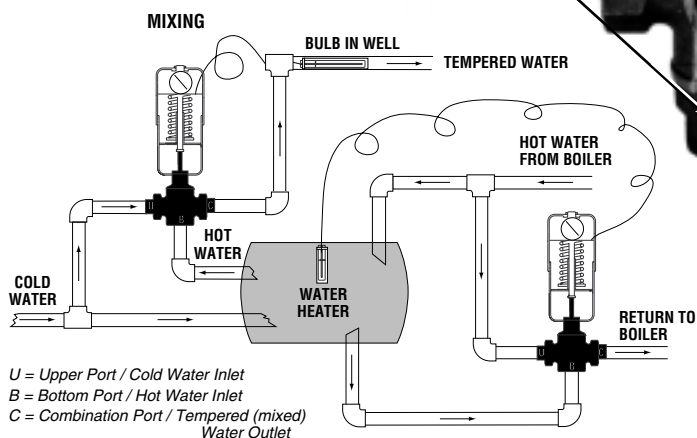

Selection

Refer to Load Calculations (page 16) to determine valve capacity required for your process.

Refer to Valve Sizing Charts (pages 16–21) to select valve size matching your capacity requirements.

How to Order

Next refer to the product number guide (pages 22–23) to match your valve and thermal system selections and determine product number.

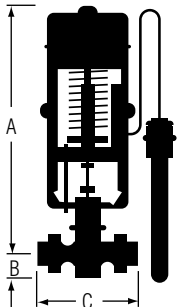

Type WM Dimensions

	Valve Style	Material and Connections	Valve Size	A in. (mm)	B in. (mm)	C in. (mm)	Shipping Weight lbs. (kg)
	Water Mix	Bronze body, screwed ends, Type WM	1/2"	14 1/8 (359)	1 3/4 (44)	2 7/8 (73)	21 (9.5)
3/4"			14 1/4 (362)	2 1/4 (57)	3 3/8 (86)	22 (10)	
1"			14 3/8 (365)	2 1/2 (64)	3 7/8 (98)	23 (10.4)	
1 1/4"			14 5/8 (371)	2 3/4 (70)	4 1/2 (114)	25 (11.3)	
1 1/2"			14 7/8 (378)	3 (76)	5 1/8 (130)	28 (12.7)	
2			15 1/4 (387)	3 3/8 (86)	6 1/8 (156)	33 (15)	

Specifications

Body: 1/2" to 2" Bronze ANSI Class 125

Connections: 1/2" to 2" Screwed Ends

Trim: Bronze (1/2" to 2" with EPT discs)

Sizes	1/2"	3/4"	1"	1 1/4"	1 1/2"	2"
C_V Mixing	4.2	7.2	12.4	20.1	25.5	39.3
C_V Bottom Port (bypass)	2.2	6.0	8.9	15.8	17.9	30
C_V Top Port (bypass)	3.5	6.0	11.2	16.7	23.7	38
Max. ΔP (PSI/kPa)	25 (150)	25 (150)	25 (150)	25 (150)	25 (150)	25 (150)

Special #11 Regulators

Powers Process Controls can build Special #11 Regulators for a wide range of applications. Always consult your factory representative for availability of any Special #11 Regulators.

For example, Powers Process Controls has developed:

- Ambient Sensing Regulator for Controlling Space Temperature or Steam Tracing Pipelines
- Nickel-Coated Regulator for Sea Water Service
- Plugged Port Three-Way Regulator for Boiler Blow Down Tempering
- Special bulbs and capillaries for OEM applications

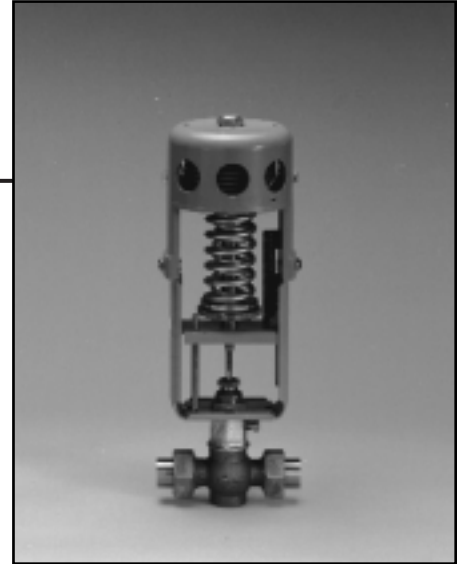

#11 Ambient Sensing Regulator

Optional Accessories

Steam Strainer

Prolongs life and prevents temperature variations due to lodged dirt or sediment between plugs and seats. Self-cleaning unit installs in steam supply line to valve.

Size	1/2"	3/4"	1"	1 1/4"	1 1/2"	2"
Order No.	043-718	043-724	043-730	043-736	043-740	043-744

Stem Lubricator

Silicone grease lubricant minimizes friction between valve stem and packing. Suitable for valves handling steam, hot and cold water, air, natural gas, oils, and most other liquids compatible with bronze or cast iron valve bodies. Temperature limits of fluid in valve: -40°F to +400°F. (Not used with Teflon V-Ring Pkg.)

Order No. 590-184A

Installation Information

No. 11 is the simplest of all temperature regulators to install because it mounts directly in the supply line—no external power requirement and no mounting brackets. **Recommended valve installation** is in vertical position (Figure 1) or in any position within 90° in either direction as shown. **Remote sensing bulb** is mounted either horizontally or vertically (end down) with bushing furnished. A special bulb must be ordered for vertical (end up) mounting (Figure 2).

Figure 1: Regulator



Figure 2: Bulb

Standard Bulb

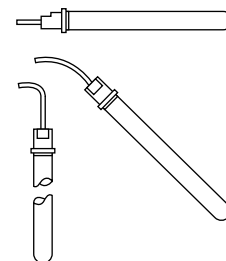

Special Bulb

Specify end-up mounting

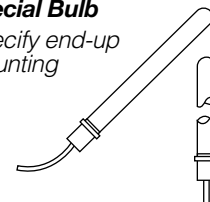

Sensing Bulbs and Protective Wells

Bulb size is usually dictated by range and valve type selected. Refer to “How to Order” information on pages 22–23 for proper bulb size.

Style D—Fixed Union Bulbs (Standard)

For rigid, pressure-tight attachment to vessel or pipeline—either directly or into socket well (see Style S wells). Union connection simplifies installation.

Nominal Dimensions (O.D. x Length)	Tank Fitting Size	Bulb & Capillary Material	Actual Dimensions (in/mm)		Pressure Rating (2) (PSI/kPa)	
			D	L	Shock	Non-Shock
1" x 9"	1" NPT	Copper	15/16" (24)	8" (203)	175 (4445)	250 (6350)
	1" NPT	347 Stainless	15/16" (24)	8 1/16" (205)	500 (12700)	725 (18415)
1" x 20"	1" NPT	Copper	15/16" (24)	19 7/8" (505)	175 (4445)	250 (6350)
	1" NPT	347 Stainless	15/16" (24)	19 13/16" (503)	500 (12700)	725 (18415)
1 1/4" x 24"	1 1/4" NPT	Copper	1 3/16" (30)	22 11/16" (576)	150 (3810)	200 (5080)
1 3/8" x 30"	1 1/4" NPT	Copper	1 3/8" (35)	28 5/8" (727)	150 (3810)	200 (5080)

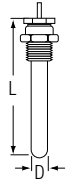

Style J—Plain Bulb (Special)

No union—for liquid or air immersion in *open* tanks or ducts. Maximum 15 foot coated capillary length.

Nominal Dimensions (O.D. x Length)	Bulb & Capillary Material	Standard Capillary Lengths (Feet)	Actual Dimensions (in/mm)	
			D	L
1" x 9"	347 Stainless	8, 15	15/16" (24)	8 3/4" (222)
	Teflon-coated (1)	15	15/16" (24)	8 3/4" (222)
1" x 20"	347 Stainless	8, 15	15/16" (24)	20 1/2" (520)
	Teflon-coated (1)	15	15/16" (24)	20 1/2" (520)

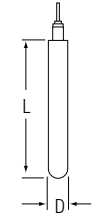

Style A—Adjustable Union Bulb (Special)

For pressure-tight insertion into tanks or ducts. Adjustable union permits capillary to be moved any desired distance through fitting and into liquid for more effective sensing bulb position.

Nominal Dimensions (O.D. x Length)	Tank Fitting Size	Bulb & Capillary Material	Actual Dimensions (in/mm)		Pressure Rating (2) (PSI/kPa)	
			D	L	Shock	Non-Shock
1" x 9"	1" NPT	347 Stainless	15/16" (24)	8 3/4" (222)	500 (12700)	725 (18415)
1" x 20"	1" NPT	347 Stainless	15/16" (24)	20 1/2" (520)	500 (12700)	725 (18415)

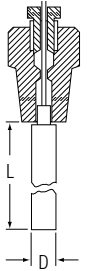

Style G—Finned Bulb (Special) Kit may be added to style “D” bulb as noted.

For air-sensing applications not corrosive to copper. Has duct-mounting flange for easy installation. Flange requires 3 1/4" dia. bolt circle; four 3/32" dia. bolt holes at 90° spacing.

Nominal Dimensions (O.D. x Length)	Bulb & Capillary Material	Actual Dimensions (in/mm)		Accessory Kit Numbers
		D	L	
1" x 9" Bulb	Copper	2" (51)	8 13/16" (224)	701-549
1" x 20" Bulb	Copper	2" (51)	20 15/16" (532)	701-550

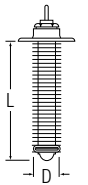

Style S Wells

For sealing Style D bulb in tanks or pipeline installation. Provides higher pressure rating and corrosion protection for bulb.

Nominal Dimensions	Tank Fitting Size	Material	Actual Dimensions		Wall Thickness	Pressure Rating*		Part No.
			D	L		D	L	
1" x 9"	1" NPT	316L Stainless	1 1/64" (27)	8 11/16" (221)	.032"	450 (3103)	675 (4654)	808-478
	1" NPT	Chrome-Plated Copper	1" (25)	9 1/16" (230)	.025"	175 (1207)	250 (1724)	709-193
1" x 20"	1" NPT	Chrome-Plated Copper	1" (25)	21" (533)	.025"	175 (1207)	250 (1724)	709-075
	1" NPT	316L Stainless	1 1/64" (27)	20 3/8" (518)	.032"	450 (3103)	675 (4654)	808-475
1 1/4" x 24"	1 1/4" NPT	347 Stainless	1 17/64" (29)	23 3/16" (592)	.032"	360 (2483)	540 (3725)	808-461
	1 1/4" NPT	Chrome-Plated Copper	1 1/4" (30)	24" (610)	.025"	150 (1035)	200 (1380)	709-128

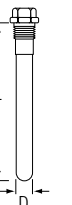

* Pressure ratings are valid up to the following temperature limits: 270°F for all copper bulbs and wells; 600°F for all others.

- Notes: (1) Teflon-coated bulb and capillary is resistant to deterioration in most metal-finishing baths and other chemical solutions at temperatures to 400°F max. (Refer to Powers Form AE-14 for information on corrosive resistance of specific solutions.)
 (2) Pressure ratings are valid up to following temperature limits: 270°F for all copper bulbs and wells; 600°F for all others.

#11 Regulator Sizing

Valve Sizing

The following sizing tables apply for *steam* or *water* input. For other media, capacities may be calculated using C_v factors—or consult factory. To prevent cycling, valve size should not exceed supply line size; preferably, it should be one or two sizes smaller.

Maximum Operating Pressure Differential

A pressure drop (differential) for fluid flow must exist across the valve. Pressure differential is the ***difference in pressure between inlet and outlet under flow conditions***. The greater the differential, the greater the flow at any plug position.

For steam, maximum flow occurs at a drop equal to approximately 50% of absolute supply pressure (gauge pressure + 15 psi). To size properly, it is necessary to know available differential at maximum flow. For best control, as much differential as possible should be taken across the valve. **For water**, use a pressure drop of at least 25% of inlet pressure.

Caution: Do not exceed maximum differentials for valve size shown in tables on pages 19–22. Too large a differential may cause valve “chatter” or prevent shutoff. The maximum differential is the pressure the valve will have against it at shutoff.

Load Calculations

For obtaining Required Amount of Heating or Cooling Medium

1. For heating or cooling water

$$\text{GPM} = \frac{\text{BTU/hr.}}{(\text{°F water temp. rise or drop}) \times 500}$$

2. For heating water with steam

$$\text{Lbs. steam / hr.} = \frac{\text{GPM}}{2} \times (\text{°F water temp rise})$$

3. For heating or cooling water with water

$$\text{GPM}_1 = \text{GPM}_2 \times \frac{\text{°F water}_2 \text{ temp rise or drop}}{\text{°F water}_1 \text{ temp rise or drop}}$$

4. For heating air with steam

$$\text{Lbs. steam / hrs.} = 1.08 \times (\text{°F air temp rise}) \times \frac{\text{CFM}}{1000}$$

5. For heating or cooling air with water

$$\text{GPM} = 2.16 \times \frac{\text{CFM} \times (\text{°F air temp. rise})}{1000 \times (\text{°F water temp drop or rise})}$$

6. For heating oil with steam

$$\text{Lbs. steam/hr.} = \frac{\text{GPM}}{4} \times (\text{°F oil temp. rise})$$

Pounds of Steam per Hour to Raise Water Temperature* ΔT

U.S. GPH	Temperature Change — $\Delta T^{\circ}\text{F}$											
	10	20	30	40	50	60	80	100	120	140	160	180
25	2.1	4.2	6.2	8.3	10	12	17	21	25	29	33	37
50	4.2	8.3	13	17	21	25	33	42	50	58	68	75
75	6.2	13	19	25	31	38	50	63	75	88	100	112
100	8.3	17	25	33	42	50	67	83	100	117	133	150
150	13	25	38	50	63	75	100	125	150	175	200	225
200	17	33	50	67	84	100	134	167	200	235	267	300
300	25	50	75	100	125	150	200	250	300	350	400	450
400	33	67	100	133	167	200	267	334	400	467	534	600
500	42	83	125	167	208	250	334	420	500	584	677	750
750	62	125	187	250	312	375	500	625	750	875	1,000	1,125
1,000	83	167	250	334	417	500	667	833	1,000	1,165	1,330	1,500
1,500	125	250	375	500	625	750	1,000	1,250	1,500	1,750	2,000	2,250
2,000	167	334	501	668	835	1,000	1,340	1,670	2,000	2,340	2,670	3,000
3,000	250	500	750	1,000	1,250	1,500	2,000	2,500	3,000	3,500	4,000	4,500
4,000	334	668	1,000	1,335	1,670	2,000	2,670	3,340	4,000	4,670	5,340	6,000

* For fuel oil, divide lbs. steam/hr. by 2.

#11 Regulator Sizing (cont'd)

See page 19 for metric equivalents.

Heating and Cooling Regulators Water Capacities (Gallons per minute)

Single Seat Stainless Steel Trim Regulators (Type ST)	Valve Size (in.)	Available Sizing Pressure Differential — Δ (PSI)																Max. Pressure Diff. Liquid
		Cv1	2	4	6	8	10	15	20	25	30	40	50	60	80	100	125	
	½A	0.25	0.35	0.50	0.61	0.71	0.79	0.97	1.1	1.3	1.4	1.6	1.8	1.9	2.2	2.5	2.8	200
	½B	0.50	0.71	1.0	1.2	1.4	1.6	1.9	2.2	2.5	2.7	3.2	3.5	3.9	4.5	5	5.6	200
	½C	1.0	1.4	2.0	2.5	2.8	3.2	3.9	4.5	5	5.5	6.3	7.1	7.7	8.9	10	11	200
	½D	2.0	2.8	4.0	4.9	5.6	6.3	7.8	9	10	11	13	14	16	18	20	22	200
	½	2.6	3.7	5.2	6.4	7.4	8.2	10	12	13	14	17	18	20	23	26	29	200
	¾	4.6	6.5	9.2	11	13	15	18	21	23	25	29	33	36	41	46	52	140
	1	10.5	15	21	26	30	32	41	47	53	58	66	74	81	—	—	—	70

Single Seat Composition Disc Regulators (Type CD) Heating only	Valve Size (in.)	Available Sizing Pressure Differential — Δ (PSI)										Liquid
		Cv1	2	4	6	8	10	15	20	25	30	
	½	3.1	4.3	6.2	7.6	8.8	9.8	12	14	16	17	30
	¾	5.5	7.8	11	14	16	17	21	25	28	30	30
	1	12	17	24	29	34	38	47	54	60	66	30
	1¼	15.8	22	32	38	45	50	61	71	79	86	30
	1½	22	31	44	54	62	70	85	98	110	120	30

Double Seat Regulators Bronze and Stainless Steel Trim (Types DS & DB)	Valve Size (in.)	Available Sizing Pressure Differential — Δ (PSI)																Liquid	
		Cv1	2	4	6	8	10	15	20	25	30	40	50	60	80	100	125	BRZ	SS
	1	13.5	19	27	33	38	43	52	60	68	74	85	96	104	120	135	156	50	150
	1¼	22	31	44	54	62	70	85	98	110	120	139	155	170	196	220	246	50	150
	1½	28	40	57	69	79	89	108	125	140	153	177	198	216	250	280	313	50	150
	2	53	75	106	130	150	167	205	236	265	290	335	374	410	473	530	562	50	125

Heating Regulators Steam Capacities (Pounds per hour)

Single Seat Stainless Steel Trim Regulators (Type ST)	Max. Pressure Differential	Valve Size (in.)	Inlet Pressure — PSIG																			
			2			5			10			15			25							
			1	2	1	2	3	5	2	4	6	8	10	2	5	10	Max. 15	2	5	10	15	Max. 20
	200	½A	3	4.2	3.3	4.5	5.5	6.9	5.1	7.1	8.5	9.6	10.4	5.6	8.7	12	13.5	6.5	10	14	16	18
	200	½B	6	8.3	6.5	9.1	11	13.8	10	14	17	19	21	11	17	23	27	13	20	28	33	36
	200	½C	12	17	13	18	22	27	20	28	34	38	42	22	35	47	54	26	40	55	65	72
	200	½D	24	33	26	36	44	55	41	57	68	76	83	45	69	93	108	52	81	111	130	144
	200	½	31	43	34	47	57	72	53	74	88	99	108	58	90	121	140	68	105	144	170	188
	140	¾	55	76	60	83	101	127	94	130	156	176	192	103	159	215	249	120	186	254	300	332
	70	1	125	175	137	191	230	289	215	297	356	401	438	236	364	490	568	274	425	581	685	759

Single Seat Stainless Steel Trim Regulators (Type ST)	Max. Pressure Differential	Valve Size (in.)	Inlet Pressure — PSIG															
			50				75				100				125	150	175	200
			10	15	20	Max. 32.5	10	25	35	Max. 45	10	25	35	Max. 57.5	Max. 70	Max. 82.5	Max. 95	Max. 107.5
	200	½A	18	22	25	29	22	33	37	41	25	37	43	52	64	75	86	98
	200	½B	36	43	49	59	43	65	75	82	49	75	87	104	127	150	173	196
	200	½C	73	87	98	118	86	130	149	163	98	150	173	209	254	300	345	391
	200	½D	145	174	196	235	173	261	298	326	197	300	346	418	508	600	690	782
	200	½	189	226	225	306	225	339	388	424	256	390	450	543	661	780	898	1016
	140	¾	334	400	452	542	398	600	687	751	452	690	797	960	1170	—	—	—
	70	1	762	913	1031	1236	—	—	—	—	—	—	—	—	—	—	—	—

#11 Regulator Sizing *(cont'd)*

See page 20 for metric equivalents.

Heating Regulators Steam Capacities (Pounds per hour)

Single Seat Composition Disc Regulators (Type CD)	Max. Pressure Differential	Valve Size (in.)	Inlet Pressure — PSIG																			
			2		5				10													
			Available Sizing Pressure Differential — PSIG																			
Steam		1	2	1	2	3	5	2	4	6	8	10										
50	1/2		37	52	40	56	68	85	63	88	105	118	129									
50	3/4		66	91	72	100	121	151	112	156	186	210	229									
50	1		143	200	157	218	263	330	245	340	407	459	500									
45	1 1/4		189	263	206	287	347	435	323	447	535	604	659									
30	1 1/2		263	366	286	400	483	606	450	623	745	841	917									
Max. Pressure Differential	Valve Size (in.)	Inlet Pressure — PSIG																				
		15			25				50													
		Available Sizing Pressure Differential — PSIG																				
Steam		2	5	10	Max. 15	2	5	10	15	Max. 20	10	15	20	Max. 32.5								
50	1/2	70	107	145	167	81	125	171	202	224	225	270	304	365								
50	3/4	124	190	257	297	144	223	304	359	397	399	478	540	648								
50	1	270	416	560	649	313	486	664	783	867	871	1044	1179	1413								
45	1 1/4	355	547	737	854	413	640	874	1031	1142	—	—	—	—								
30	1 1/2	495	762	1027	1189	575	891	1217	1436	1590	—	—	—	—								
Double Seat Regulators Bronze and Stainless Steel Trim* (Types DS & DB)	Max. Pressure Differential	Valve Size (in.)	Inlet Pressure — PSIG																			
			2		5				10				15									
			Available Sizing Pressure Differential — PSIG																			
Steam		1	2	1	2	3	5	2	4	6	8	10	2	5	10	Max. 15						
50 150	1	161	225	176	245	296	372	276	382	457	516	563	304	467	630	728						
50 150	1 1/4	263	366	286	400	483	606	450	623	745	841	917	495	762	1027	1189						
50 150	1 1/2	335	466	364	508	614	771	572	792	949	1070	1167	630	970	1307	1513						
50 125	2	633	882	690	963	1163	1460	1084	1500	1795	2025	2209	1192	1836	2474	2865						
Max. Pressure Differential	Valve Size (in.)	Inlet Pressure — PSIG																				
		25			50				75				100			125	150	175	200			
		Available Sizing Pressure Differential — PSIG																				
Steam		2	5	10	15	Max. 20	10	15	20	Max. 32.5	10	25	35	Max. 45	10	25	35	Max. 57.5	70	82.5	95	107.5
50 150	1	353	547	747	881	975	980	1174	1326	1590	1167	1761	2015	2204	1328	2026	2338	2818	3432	4029	4644	5258
50 150	1 1/4	575	891	1217	1436	1590	1596	1914	2161	2591	1901	2870	3284	3592	2164	3302	3811	4593	5594	6567	7568	8569
50 150	1 1/2	731	1134	1549	1827	2023	2032	2436	2750	3297	2420	3653	4180	4571	2754	4203	4850	5845	7119	8357	9631	10903
50 125	2	1385	2147	2932	3459	3829	3846	4610	5206	6241	4581	6915	7912	8652	5213	7956	9181	11064	13475	15819	18231	20642

*Note: Always use S.S. trim over 50 psig.

#11 Regulator Sizing: Metric Equivalentents

See page 17 for English units.

Heating and Cooling Regulators Water Capacities (Liters per second)

Single Seat Stainless Steel Trim Regulators (Type ST)	Valve Size (in.)	Available Sizing Pressure Differential — Δ (kPa)															Max. Pressure Diff. Liquid	
		7	15	30	45	60	75	100	125	150	200	250	350	450	550	650		750
	½"A	0.02	0.02	0.03	0.04	0.05	0.05	0.06	0.07	0.07	0.08	0.09	0.11	0.13	0.14	0.15	0.16	1379
	½"B	0.03	0.05	0.07	0.08	0.09	0.1	0.12	0.13	0.15	0.17	0.19	0.22	0.25	0.28	0.31	0.33	1379
	½"C	0.06	0.09	0.13	0.16	0.19	0.21	0.24	0.27	0.29	0.34	0.38	0.45	0.51	0.56	0.61	0.66	1379
	½"D	0.13	0.19	0.26	0.32	0.37	0.42	0.48	0.54	0.59	0.68	0.76	0.9	1.02	1.13	1.22	1.32	1379
	½"	0.17	0.24	0.34	0.42	0.48	0.54	0.62	0.7	0.76	0.88	0.99	1.17	1.32	1.46	1.59	1.71	1379
	¾"	0.29	0.43	0.61	0.74	0.86	0.96	1.11	1.24	1.35	1.56	1.75	2.07	2.34	2.59	2.82	3.03	965
	1"	0.7	1.02	1.45	1.77	2.05	2.29	2.64	2.95	3.24	3.74	4.18	4.94	5.61	—	—	—	483

Single Seat Composition Disc Regulators (Type CD) Heating only	Valve Size (in.)	Available Sizing Pressure Differential — Δ (kPa)										Liquid	
		7	15	30	45	60	75	100	125	150	200	BRZ	SS
	½"	0.2	0.3	0.4	0.5	0.6	0.6	0.7	0.8	0.9	1.1	207	207
	¾"	0.3	0.5	0.7	0.9	1.0	1.1	1.3	1.5	1.6	1.9	207	207
	1"	0.8	1.1	1.6	1.9	2.2	2.5	2.9	3.2	3.5	4.1	207	207
	1¼"	1.0	1.5	2.1	2.6	3.0	3.3	3.8	4.3	4.7	5.4	207	207
	1½"	1.4	2.0	2.9	3.5	4.1	4.6	5.3	5.9	6.5	7.5	207	207

Double Seat Regulators Bronze and Stainless Steel Trim (Types DS & DB)	Valve Size (in.)	Available Sizing Pressure Differential — Δ (kPa)															Liquid		
		7	15	30	45	60	75	100	125	150	200	250	350	450	550	650	750	BRZ	SS
	1"	0.9	1.3	1.8	2.2	2.5	2.8	3.2	3.6	4.0	4.6	5.1	6.1	6.9	7.6	8.3	8.9	345	1034
	1¼"	1.4	2.0	2.9	3.5	4.1	4.6	5.3	5.9	6.5	7.5	8.4	9.9	11	12	13	14	345	1034
	1½"	1.8	2.6	3.7	4.5	5.2	5.8	6.7	7.5	8.2	9.5	11	13	14	16	17	18	345	1034
	2"	3.4	4.9	7.0	8.5	9.9	11	13	14	16	18	20	24	27	30	32	35	345	862

Heating Regulators Steam Capacities (Kilograms per hour)

Single Seat Stainless Steel Trim Regulators (Type ST)	Max. Pressure Differential	Valve Size (in.)	Inlet Pressure — kPa																		
			15			30			70			100			175						
			Available Sizing Pressure Differential — PSIG																		
Steam	5	15	5	10	15	30	5	10	15	35	70	10	25	50	Max. 100	10	25	50	100	Max. 140	
1379	½"A	1.2	2	1.2	1.7	2.1	2.9	1.4	2	2.4	3.6	4.8	2.2	3.4	4.6	6	2.5	4	5.5	7.3	8.3
1379	½"B	2.3	3.9	2.5	3.5	4.2	5.8	2.8	4	4.8	7.2	9.5	4.3	6.7	9.2	12	5.1	7.9	11	15	17
1379	½"C	4.7	7.9	5	6.9	8.4	12	5.7	8	9.7	14	19	8.7	13.4	18.3	24	10	16	22	29	33
1379	½"D	9.3	16	9.9	14	17	23	11	16	19	29	38	17	27	37	48	20	32	44	59	66
1379	½"	12	21	13	18	22	30	15	21	25	37	50	23	35	48	62	26	41	57	76	86
965	¾"	21	36	23	32	39	53	26	37	45	66	88	40	62	84	111	47	73	101	135	153
483	1"	49	83	52	73	88	121	60	84	102	151	200	91	141	193	252	107	167	230	309	349

Max. Pressure Differential	Valve Size (in.)	Inlet Pressure — kPa															
		350				500				700				850	1000	1200	1400
		Available Sizing Pressure Differential — PSIG															
Steam	10	50	150	Max. 250	70	175	250	Max. 301	70	175	250	Max. 401	Max. 476	Max. 551	Max. 651	Max. 751	
1379	½"A	3.3	7.1	12	14	10	15	17	18	11	17	20	24	28	33	39	45
1379	½"B	6.5	14	23	28	19	29	34	36	23	35	40	48	57	66	78	90
1379	½"C	13	29	46	56	39	59	67	72	45	69	80	96	114	132	156	180
1379	½"D	26	57	93	112	78	117	135	144	90	138	161	192	228	264	311	359
1379	½"	34	74	121	145	101	152	175	187	118	180	209	249	296	343	405	467
965	¾"	60	131	213	257	179	269	310	331	208	318	369	441	524	—	—	—
483	1"	137	299	487	586	—	—	—	—	—	—	—	—	—	—	—	—

#11 Regulator Sizing: Metric Equivalents *(cont'd)*

See page 18 for English units.

Heating Regulators Steam Capacities (Kilograms per hour)

Single Seat Composition Disc Regulators (Type CD)	Max. Pressure Differential	Valve Size (in.)	Inlet Pressure — kPa																				
			15		30				70														
			Available Sizing Pressure Differential — PSIG																				
Steam	5	15	5	10	15	30	5	10	15	35	70												
345	1/2"	14	24	15	22	26	36	18	25	30	44	59											
345	3/4"	26	43	27	38	46	63	31	44	53	79	105											
345	1"	56	95	60	83	101	139	68	96	116	172	229											
310	1 1/4"	75	126	79	111	135	185	91	127	155	229	305											
207	1 1/2"	103	174	109	153	185	254	125	175	213	315	420											
	Max. Pressure Differential	Valve Size (in.)	Inlet Pressure — kPa																				
			100				175				350												
			Available Sizing Pressure Differential — PSIG																				
Steam	10	25	50	Max. 100	10	25	50	100	Max. 140	10	50	150	Max. 250										
345	1/2"	27	42	57	75	32	49	68	91	103	40	88	144	173									
345	3/4"	48	74	101	132	56	87	120	162	183	72	157	255	307									
345	1"	104	161	220	288	122	190	263	353	398	157	342	557	607									
310	1 1/4"	138	215	293	385	163	254	350	470	531	—	—	—	—									
207	1 1/2"	190	295	404	529	224	349	482	647	730	—	—	—	—									
Double Seat Regulators Bronze and Stainless Steel Trim* (Types DS & DB)	Max. Pressure Differential	Valve Size (in.)	Inlet Pressure — kPa																				
			15		39				70				100										
			Available Sizing Pressure Differential — kPa																				
Steam	Bronze	SS	5	15	5	10	15	30	5	10	15	35	70	10	25	50	Max. 100						
345	1034	1"	63	107	67	94	114	156	77	108	131	194	258	117	181	248	324						
345	1034	1 1/4"	103	174	109	153	185	254	125	175	213	315	420	190	295	404	529						
345	1034	1 1/2"	131	221	139	194	236	323	159	223	271	401	534	242	376	514	673						
345	1034	2"	247	418	263	368	446	612	301	422	513	760	1012	459	711	972	1274						
	Max. Pressure Differential	Valve Size (in.)	Inlet Pressure — kPa																				
			175				350				500				700		850	1000	1200	1400			
			Available Sizing Pressure Differential — kPa																				
Steam	Bronze	SS	10	25	50	100	Max. 140	10	50	150	Max. 250	70	175	250	Max. 301	70	175	250	Max. 401	476	551	651	751
345	1034	1"	137	214	296	397	448	176	385	627	753	525	791	910	971	611	932	1084	1294	1537	1779	2102	2425
345	1034	1 1/4"	224	349	482	647	730	287	627	1021	1228	856	1289	1483	1583	995	1519	1767	2109	2504	2899	3425	3952
345	1034	1 1/2"	285	444	613	823	930	365	799	1300	1562	1089	1640	1887	2015	1267	1933	2249	2685	3187	3689	4359	5029
345	1034	2"	539	841	1161	1558	1760	692	1512	2460	2957	2061	3105	3573	3814	2398	3659	4257	5082	6033	6984	8252	9520

*Note: Always use S.S. trim over 50 psig.

Sizing Mixing Regulators

Water Capacities (Gallons per Minute/Liters per Second)

3-Way Mixing Valves (Type WM)

The following water capacities of Powers #11 Regulator 3-way valves are based on piping as shown. The cold water supply line must be connected to the upper inlet "U". Hot water supply must be connected to bottom inlet "B". Side port "C" is the outlet for the mixed water.

Note: 3-way regulators perform poorly with less than 8 lb. pressure differential.

Tempered water systems should employ downstream high temperature limit controls (Powers AquaSentry) to protect users from scalding in the event of regulator failure.

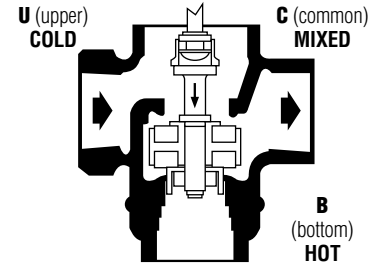

Maximum MIXED FLOW for Tempering Applications

Gallons per Minute

Liters per Second

Valve Size (in.)	Available Sizing Pressure Differential* — Δ (PSI)												Valve Size (in.)	Available Sizing Pressure Differential* — Δ (kPa)														
	Cv1	2	4	6	8	10	15	20	25	30	40	50		7	15	30	45	60	75	100	125	150	200	250	350			
1/2	4.2	5.9	8.4	10	12	13	16	19	21	23	27	30	1/2	0.3	0.4	0.6	0.7	0.8	0.9	1	1.1	1.2	1.4	1.6	1.9			
3/4	7.2	10	14	18	20	23	28	33	36	39	46	51	3/4	0.5	0.7	0.9	1.2	1.3	1.5	1.7	1.9	2.1	2.4	2.7	3.2			
1	12.4	18	25	30	35	39	48	55	62	68	78	88	1	0.8	1.1	1.6	1.9	2.2	2.5	2.9	3.2	3.5	4.1	4.6	5.4			
1 1/4	20.1	28	40	49	57	64	78	90	100	110	127	142	1 1/4	1.3	1.9	2.6	3.2	3.7	4.2	4.8	5.4	5.9	6.8	7.5	9			
1 1/2	25.5	36	51	62	72	81	99	114	127	140	161	180	1 1/2	1.6	2.3	3.3	4	4.7	5.2	6	6.7	7.4	8.5	9.5	11			
2	39.3	55	79	96	111	124	152	176	197	215	248	278	2	2.5	3.6	5.1	6.3	7.3	8.1	9.4	10	11	13	15	18			

For sizes 2 1/2, 3, and 4, use "Bottom Port" table.

For sizes 2 1/2, 3, and 4, use "Bottom Port" table.

Full Flow through BOTTOM Port (upper port closed) for By-Pass Applications

Gallons per Minute

Liters per Second

Valve Size (in.)	Available Sizing Pressure Differential [▲] — Δ (PSI)												Valve Size (in.)	Available Sizing Pressure Differential [▲] — Δ (kPa)														
	Cv1	2	4	6	8	10	15	20	25	30	40	50		7	15	30	45	60	75	100	125	150	200	250	350			
1/2	2.2	3.1	4.4	5.4	6.2	7.0	8.5	9.8	11.0	12	27	16	1/2	0.1	0.2	0.3	0.4	0.4	0.5	0.5	0.6	0.6	0.7	0.8	1			
3/4	6.0	8.5	12	15	17	19	23	27	30	33	38	42	3/4	0.4	0.6	0.8	1	1.1	1.2	1.4	1.6	1.8	2	2.3	2.7			
1	8.9	13	18	22	25	28	34	40	45	49	56	63	1	0.6	0.8	1.2	1.4	1.7	1.9	2.1	2.4	2.6	3	3.4	4			
1 1/4	15.8	22	32	39	45	50	61	71	79	87	100	112	1 1/4	1	1.5	2.1	2.6	3	3.3	3.8	4.3	4.7	5.4	6.1	7.2			
1 1/2	17.9	25	36	44	51	57	69	80	89	98	113	127	1 1/2	1.1	1.7	2.4	2.9	3.3	3.7	4.3	4.8	5.3	6.1	6.8	8.1			
2	30.2	43	60	74	85	95	117	135	151	165	191	213	2	1.9	2.8	3.9	4.8	5.6	6.2	7.2	8.1	8.8	10	11	13			

Full Flow through UPPER Port (bottom port closed) for By-Pass Applications

Gallons per Minute

Liters per Second

Valve Size (in.)	Available Sizing Pressure Differential [▲] — Δ (PSI)												Valve Size (in.)	Available Sizing Pressure Differential [▲] — Δ (kPa)														
	Cv1	2	4	6	8	10	15	20	25	30	40	50		7	15	30	45	60	75	100	125	150	200	250	350			
1/2	3.5	5.0	7.0	8.6	9.9	11.0	13.0	16.0	18	19	22	25	1/2	0.2	0.3	0.5	0.6	0.7	0.7	0.8	0.9	1.0	1.2	1.3	1.6			
3/4	6.0	8.5	12	15	17	19	23	27	30	33	38	42	3/4	0.4	0.6	0.8	1.0	1.1	1.2	1.4	1.6	1.8	2.0	2.3	2.7			
1	11.2	16	22	27	32	35	43	50	56	61	71	79	1	0.7	1.0	1.4	1.8	2.0	2.3	2.6	3.0	3.2	3.7	4.2	4.9			
1 1/4	16.7	24	33	41	47	53	64	75	84	92	106	118	1 1/4	1.1	1.6	2.2	2.7	3.2	3.5	4.1	4.6	5.0	5.8	6.5	7.6			
1 1/2	23.7	34	47	58	67	75	92	106	119	130	150	168	1 1/2	1.5	2.2	3.2	3.9	4.5	5.0	5.8	6.4	7.1	8.2	9.1	11			
2	38.1	54	76	93	108	120	147	170	190	208	241	269	2	2.4	3.5	5.0	6.1	7.1	7.9	9.1	10	11	13	14	17			

Notes: * Pressure difference between lowest of inlet and outlet pressures. Piping should be arranged so that inlet pressures are equal.
[▲] Pressure difference between open port and outlet.

How to Order...

Indicate the entire digit code(s) when ordering.

595 - -

Complete #11 Regulators

Lower Housing

Determine the order code from the lower housing assembly code chart below. Eliminate the 590 prefix when ordering a complete regulator.

Thermal System

Determine the code from the thermal system code chart (page 23). Eliminate the 700 prefix when ordering a complete regulator.

#11 Lower Housing Assemblies

590 -

Valve Type				Order Code
Seat	Packing	Body	Trim	
Single Comp	EP (heating)	Bronze	Bronze	CD
Single	TFE (H) EP (C)	Bronze	Stainless	ST
Double	EP (H & C)	Bronze	Bronze	DB
Double	TFE (H) EP (C)	Bronze	Stainless	DS
Mixing	EP (Mixing)	Bronze	Bronze	WM

Size	Style					Order Code
	CD	ST	DB	DS	WM	
1/2A		■				A50
1/2B		■				B50
1/2C		■				C50
1/2D		■				D50
1/2	■	■			■	050
3/4	■	■			■	075
1	■	■	■	■	■	100
1-1/4	■		■	■	■	125
1-1/2	■		■	■	■	150
2			■	■	■	200

Valve Action	Order Code
Heating	H
Cooling (not available in Type CD body style)	C
Mixing (WM only)	M

#11 Thermal Systems

700 -

Bulb and Capillary Material

Copper (with 8' capillary).....
 Stainless Steel (with 8' capillary).....

Capillary Length

8'
 15' (copper)
 15' (stainless steel)
 30' (copper)
 30' (stainless steel)

Bulb Style

Fixed Union
 No Pipe Fittings
 Adj. Union
 D Vertical

Head Assembly

• 2½" – 4" Water Mix Bodies

Range codes 22–28

• All other bodies

Non-Indicating
 Indicating

Order Code

C

S

08

15

15

30

30

D

J

A

V

H

N

I

Range/Bulb Size Code (two-digit codes below)

All ranges/bulb sizes listed below are **no charge**.

Select range with setpoint in **upper third** for best performance. Consult factory for ranges/bulb sizes not listed.

Temperature Ranges

Single or Double Seat Valves : Sizes 1/2" through 2"

Range/Bulb Size Codes	Heating D.A.	Cooling R.A.	Water Mix 1/2" to 2"
1" x 20" Bulb	01 10° to 70°F	0 to 60°F	10° to 60°F
	02 55° to 115°F	45° to 105°F	55° to 115°F
	03 85° to 145°F	70° to 130°F	80° to 140°F
	04 90° to 150°F	100° to 160°F	
1" x 9" Bulb	05 110° to 170°F	110 to 150°F	110° to 160°F
	06	06 no longer available. Substitute either 05 or 07.	
	07 140° to 200°F	120° to 180°F	135° to 195°F
	08 170° to 230°F	150° to 210°F	160° to 220°F
	09 200° to 250°F	185° to 245°F	200° to 250°F
	10 230° to 290°F	220° to 280°F	230° to 280°F
	11 270° to 330°F	255° to 315°F	260° to 320°F

Double Seat : Valve Sizes 2-1/2" through 4"

Range/Bulb Size Codes	Heating D.A.	Cooling R.A.	Water Mix	
1-1/4" x 24" Bulb*	12 10° to 70°F	0 to 60°F	Not applicable	
	13 55° to 115°F	45° to 105°F		
	14 85° to 145°F	70° to 130°F		
	44 90° to 150°F	100° to 160°F		
1" x 20" Bulb	15 110° to 170°F		Not applicable	
	16	16 no longer available. Substitute either 15 or 17.		
	17 140° to 200°F	120° to 180°F		
	18 170° to 230°F	150° to 210°F		
	19 200° to 250°F	185° to 245°F		
	20 230° to 290°F	220° to 280°F		
	21 270° to 330°F	225° to 315°F		

High Power Head Assembly for 2-1/2" – 4" Water Mix

1-3/8" x 30" Bulb	28	Below 110°F	50° to 80°F
	22		70° to 100°F
	23		95° to 125°F

High Power Head Assembly for 2-1/2" – 4" Water Mix

1-1/4" x 24" Bulb*	24	Above 110°F	120° to 150°F
	25		140° to 170°F
	26		150° to 180°F
	27		180° to 210°F

* Not available in stainless steel

POWERS™

© December 2004 Powers, a division of Watts Water Technologies, Inc.
USA Phone: 800-669-5430 • Fax: 847-824-0627 • Canada Phone: 1.888.208.8927 • Fax: 1.888.882.1979
www.powerscontrols.com

Form B #11 v3 0448

Printed in U.S.A.